

Rover K

NC processing centre



 **BIESSE**

When competitiveness means growth

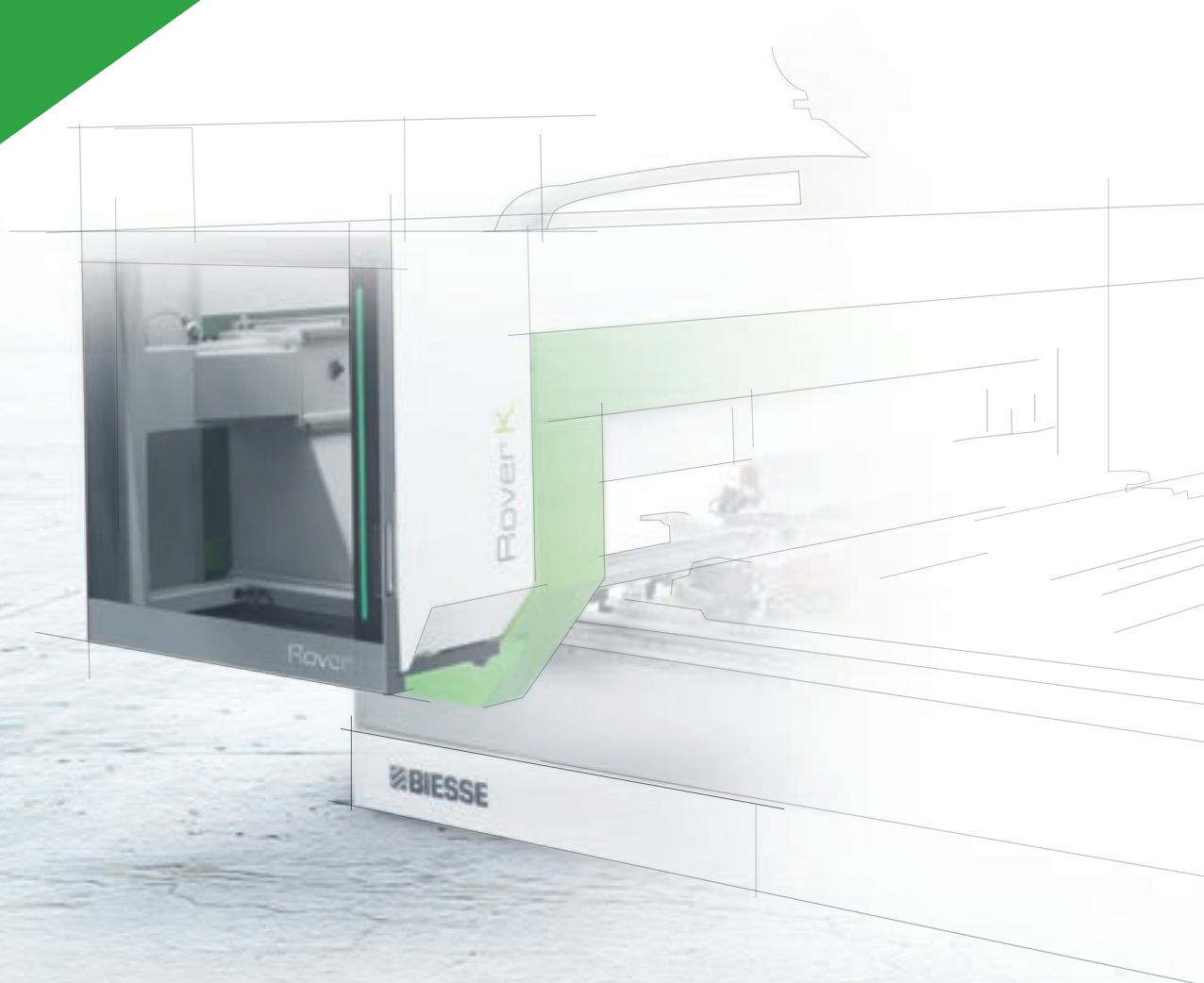

Made **In** Biesse

The market demands

a change in manufacturing processes that enables companies to **accept the largest possible number of orders**. This is coupled with the need to maintain high quality standards whilst offering product customisation with **quick and defined delivery times**, as well as responding to the needs of highly creative designers.

Biesse meets these requirements

with **technological solutions** that influence and support technical expertise as well as process and material knowledge. **Rover K** is an NC processing centre designed for craftsmen who need to automate their production process as well as small-medium enterprises that specialise in custom-made products.

- ▶ A single processing centre for the manufacturing of solid wood and particle board furniture.
- ▶ Consistent processing quality over time.
- ▶ Panel and work area cleaning.
- ▶ Maximum operator safety.
- ▶ High-tech becomes accessible and intuitive.

The first investment
for great growth



Rover K
NC processing centre

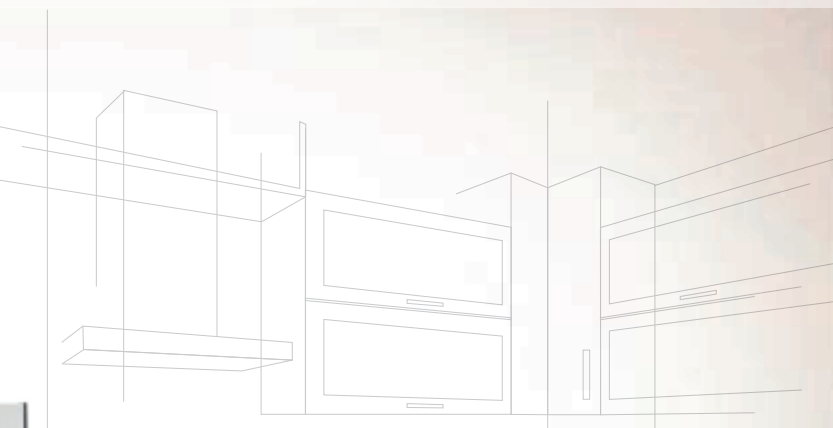

A single processing centre for the manufacture of solid wood and particle board furniture

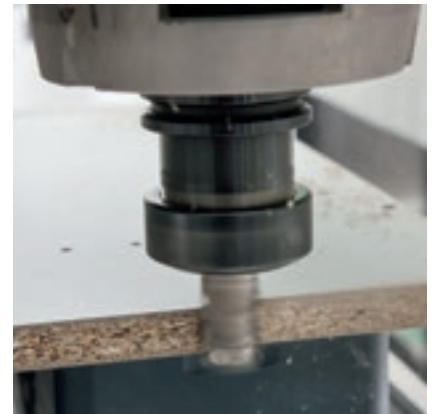

Rover K, available in two sizes, is equipped with 3 or 4 independent and interpolation axes and can be fitted with aggregates capable of handling any type of machining operation.

The components of Rover K configurations are the same as those one used in higher-end solutions. The electrospindle, boring head and aggregates are designed and manufactured for Biesse by HSD, the global leader in this sector.

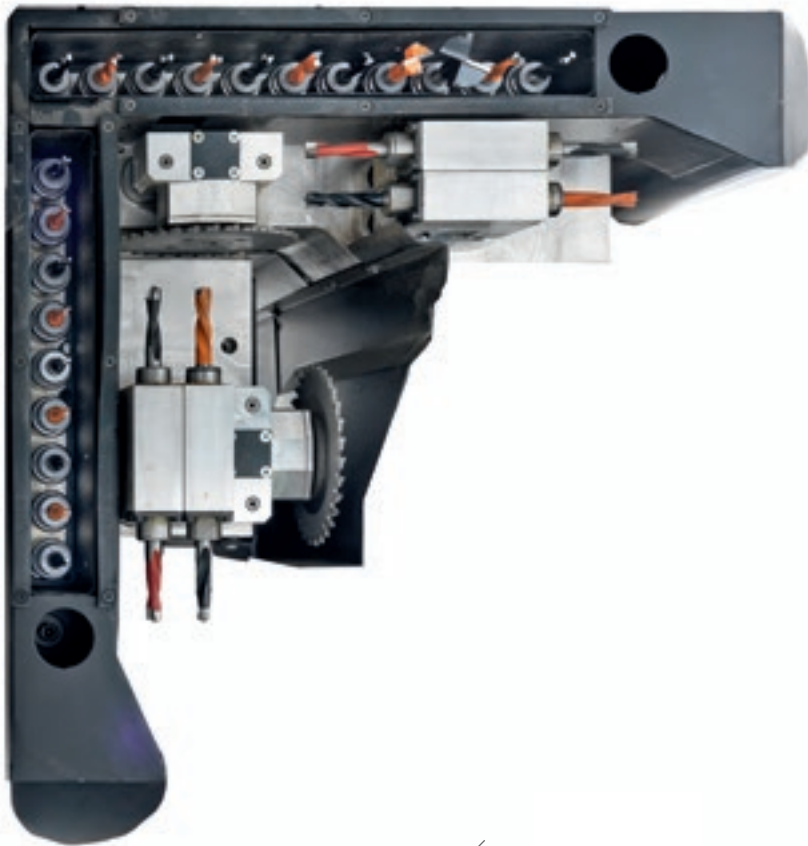

The new BH 30 2L boring head is also available and is equipped with automatic lubrication and highly efficient rigid vacuum hood for a cleaner environment, as well as with liquid cooling to ensure maximum precision.



The cross-head thickness tracer enables operators to measure panel dimensions with absolute precision.



New C Torque axis:
more precise, quicker,
more rigid.

Reduced tool changeover time

The Biesse work table is guaranteed to hold the work piece securely in place and ensures quick and easy tool changeover.



SA (Set Up Assistance), the assisted set-up work table instructs to the operator how to position the panel, (indicating the position of work tables and blocking systems) and protects the work area from any collisions with the tool.



Uniclamp clamps with pneumatic system.



Different references for the machining of multiple components.



The Pick Up station supports automatic tool-holder rack tooling.



Thanks to the 16 position tool-changer, tools and aggregates are always available, without the need for operator intervention when moving from one machining process to the next.



Practical design

The transparent polycarbonate reinforced protection door is designed to guarantee maximum visibility for the operator. Fitted with 5-colour LEDs indicating machine status, it ensures that processing phases can be easily and safely monitored.

BIESSE IDENTITY

An innovative yet simple design is the hallmark of Biesse's distinctive identity. The perfect combination of Italian genius and taste.

ROVER

Long term quality and reliability

The Gantry structure has been designed to improve the precision and reliability of machining operations.



Rigidity and absence of vibration ensures constant and reliable quality of machined components.



The double X-axis motorisation available in the 1532 model supports high speeds and accelerations whilst ensuring high quality finish and precision.

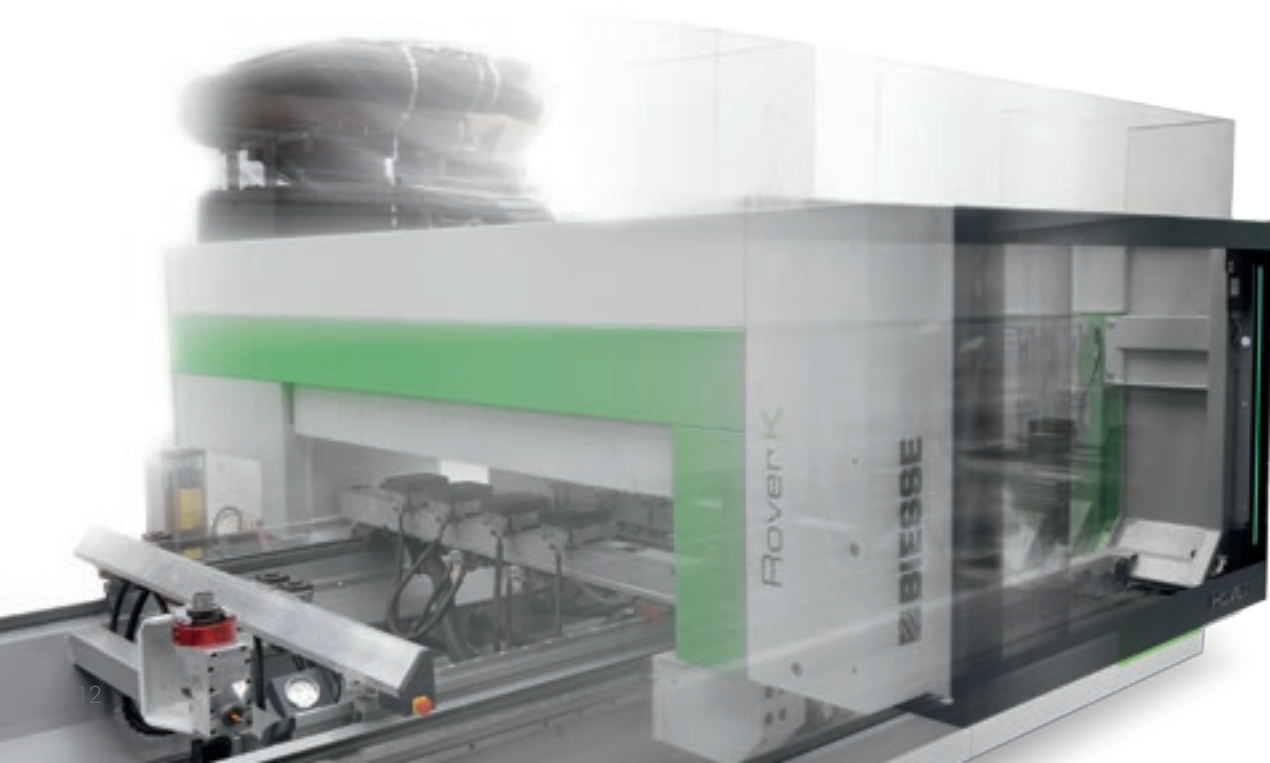

Optimal cleaning of machined piece and work area



Motorised conveyor belt for the removal of chips and waste.



NC-controlled deflector (chip conveyor).



Adjustable suction hood with 6 settings.

Maximum operator safety

The fully enclosed working units with perspex window, ensures maximum visibility and total safety.



Perimeter guards with access door and safety device.



Long term safety and reliability thanks to the solution with only **bumpers** or **bumpers** combined with **photocells** with no footprint or mechanical wear.

Maximum safety thanks to **pressure-sensitive floor mats** that enable the machine to operate at constant maximum speed.



All functions
at your fingertips.

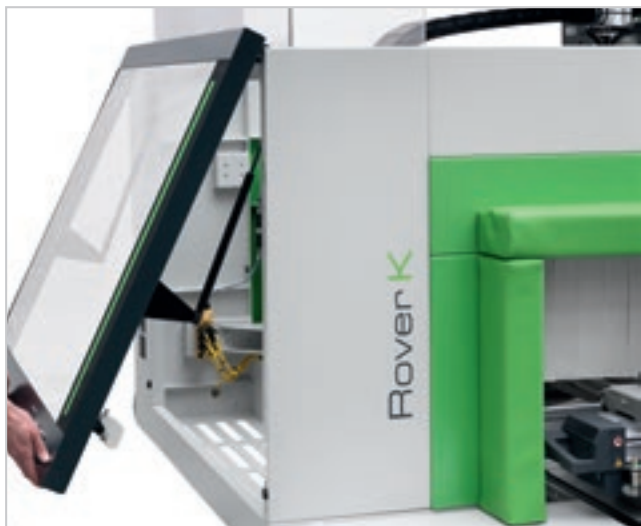

New hood with openable Lexan
front door, for ease of operation.

LED bar with 5 colours showing
machine status in real time.



The most advanced technology close at hand



bPad

Wi-Fi control console for performing the key functions required during the preparation of the working area and the tooling of the working units and tool holder warehouses. The bPad is a valuable tool for supporting teleservicing, courtesy of the camera and bar code reader functions.

bTouch

The new 21.5" touch screen which enables you to carry out all of the functions previously performed using the mouse and the keyboard, enhancing the direct interaction between the user and the device. Perfectly integrated with the bSuite 3.0 interface (and with later versions) and optimised for touch, this solution is incredibly simple, and makes the best possible use of the Biesse software functions installed on the machine.

bPad and bTouch are an optional feature which can also be bought after purchasing the machine, in order to improve the functionality and application of the technology available.



Industry 4.0 ready



Industry 4.0 is the new industry frontier, based on digital technologies and on machines that speak to companies. The products driving this revolution can communicate and interact independently within production processes, which in turn are connected via intelligent networks.



Biesse is dedicated to transforming the factories owned by our customers into real-time factories that are ready to provide digital manufacturing opportunities. Intelligent machines and software become indispensable tools that facilitate the daily work of those who machine wood and other materials on a daily basis.

Service 4.0

Biesse has developed a wide range of services to enhance machine performance and customer productivity, improving operational efficiency and lowering costs.

Sensors and devices fitted onto machines enable in-depth analyses to be carried out and viewed via control panels for mobile devices.



CNC IoT Biesse Service Pack

- ▶ Priority service and extended coverage.
- ▶ Continuous connection with the Biesse control centre.
- ▶ Direct monitoring of machine performance through a dedicated app.
- ▶ Analysis of machine stoppages, remote diagnostics and fault prevention.
- ▶ On-site functional check and technical inspection within the warranty period.

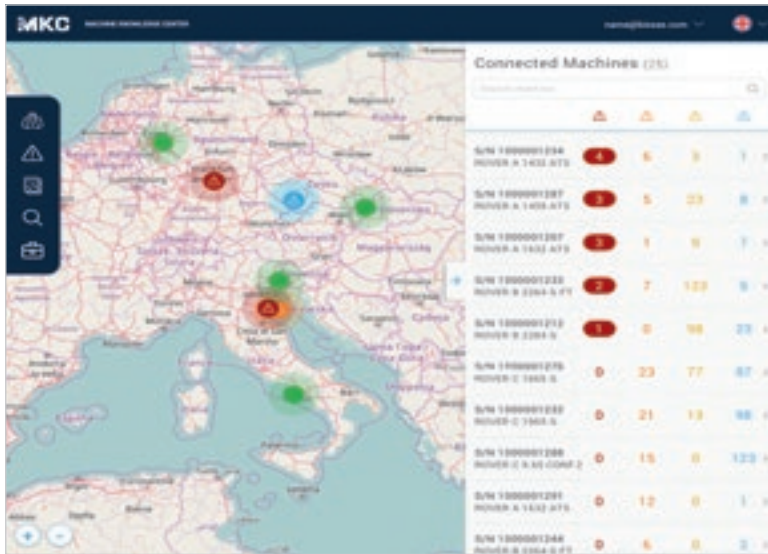

Machine monitoring screen connected to the Biesse control centre.



Control screen displaying machine details.

The direct connection with Biesse provides a range of significant benefits

- ▶ Optimisation of efficiency and of operating quality.
- ▶ Net reductions in repair times.
- ▶ Better accuracy in predicting machine stoppages.
- ▶ Remote software updates.

60 minutes maximum time taken to deal with an instance of machine stoppage.

80% reduction in the time required for the diagnostics process.

Overall reduction in downtime of **50%**.

High-tech becomes accessible and intuitive



bSolid is a 3D cad cam software program that supports the performance of any machining operation thanks to vertical modules designed for specific manufacturing processes.

- ▶ **Planning in just a few clicks, with endless possibilities.**
- ▶ **Simulating machining operations to visualise the piece ahead of manufacturing and have some guidance for the planning phase.**
- ▶ **Virtual prototyping of the piece to avoid collisions and ensure optimal machine equipment.**

Watch the **bSolid** ad at: youtube.com/biessegroup



bSolid



Configuration

Powerful and compact, high-performing
on both panel and solid wood.

Complete and compact working unit configuration, capable of handling any machining operation with the smallest possible footprint.

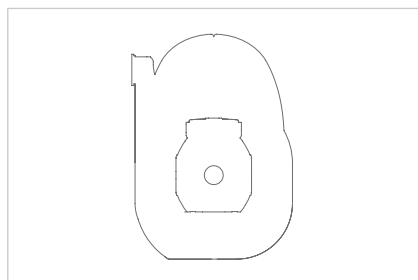

Electrospindle
13.2-19.2 kW.

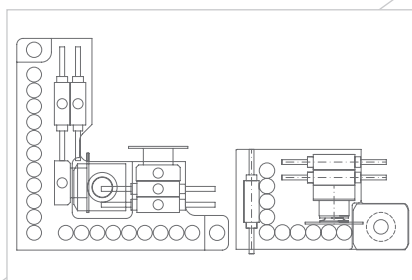

Boring head:
BH17 – BH30 2L.

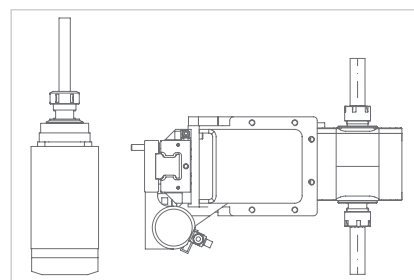

Horizontal
1 or 2 outlet electrospindle.

Working table

	ROVER K 1232	ROVER K 1532
	(mm / inch)	(mm / inch)
X CE	3260 / 128	3260 / 128
X NCE	3200 / 126	3200 / 126
Y	1260 / 50	1560 / 61
Z	165 / 6	165 / 6

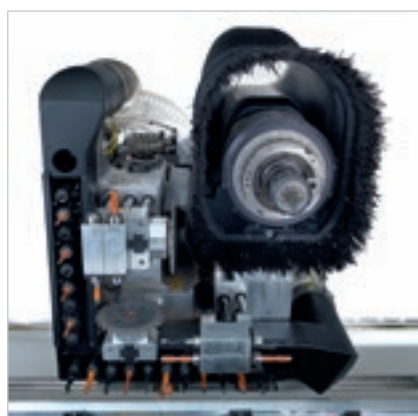

Technical specifications

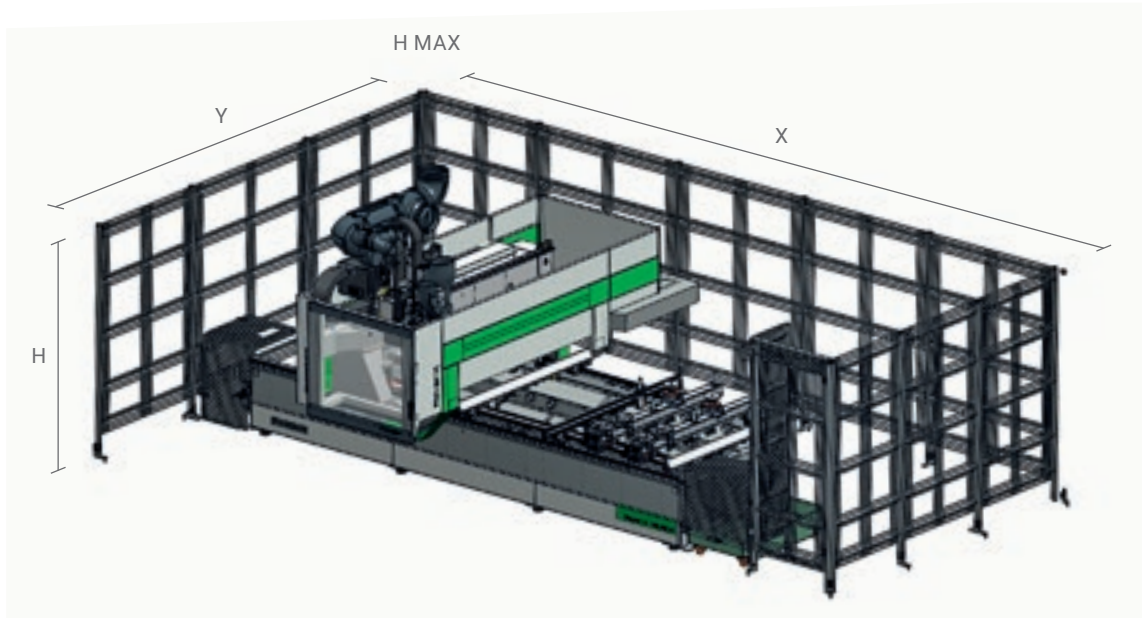

Working table

	ROVER K 1232			ROVER K 1532		
	(mm / inch)	(mm / inch)	(mm / inch)	(mm / inch)	(mm / inch)	(mm / inch)
	CE mats	CE photocells	NCE	CE mats	CE photocells	NCE
X	6745/266	6745/266	6680/263	6745/266	6745/266	6680/263
Y	4174/165	4381/173	4468/176	4517/178	4681/185	4768/188
H	2000/79	2000/79	2000/79	2000/79	2000/79	2000/79
H MAX	2400/95	2400/95	2400/95	2400/95	2400/95	2400/95
X/Y/Z axis speed	60/60/20 m/min - 196/196/65 foot/min			85/60/20 m/min - 278/196/65 foot/min		
Vector speed	85 m/min - 278 foot/min			104 m/min - 341 foot/min		

The technical specifications and drawings are non-binding. Some photos may show machines equipped with optional features. Biesse Spa reserves the right to carry out modifications without prior notice.

A weighted sound pressure level (LpA) during machining for operator workstation on vane-pump machine Lpa=79dB(A) Lwa=96dB(A) A-weighted sound-pressure level (LpA) for operator workstation and sound power level (LwA) during machining on cam-pump machine Lwa=83dB(A) Lwa=100dB(A) K measurement uncertainty dB(A) 4

The measurement was carried out in compliance with UNI EN 848-3:2007, UNI EN ISO 3746: 2009 (sound power) and UNI EN ISO 11202: 2009 (sound pressure levels at workstation) during panel machining. The noise levels shown are emission levels and do not necessarily correspond to safe operation levels. Despite the fact that there is a relationship between emission and exposure levels, this may not be used in a reliable manner to establish whether further measures need to be taken. The factors determining the exposure level for the workforce include length of exposure, work environment characteristics, other sources of dust and noise, etc. i.e. the number of other adjoining machines and processes. At any rate, the above information will enable the operator to better evaluate dangers and risks.

Service & Parts

Direct, seamless co-ordination of service requests between Service and Parts.
Support for Key Customers by dedicated Biesse personnel, either in-house and/or at the customer's site.

Biesse Service

- ▶ Machine and system installation and commissioning.
- ▶ Training centre dedicated to Biesse Field engineers, subsidiary and dealer personnel; client training directly at client's site.
- ▶ Overhaul, upgrade, repair and maintenance.
- ▶ Remote troubleshooting and diagnostics.
- ▶ Software upgrade.

500 / Biesse Field engineers in Italy and worldwide.

50 / Biesse engineers manning a Teleservice Centre.

550 / certified Dealer engineers.

120 / training courses in a variety of languages every year.

The Biesse Group promotes, nurtures and develops close and constructive relationships with customers in order to better understand their needs and improve its products and after-sales service through two dedicated areas: Biesse Service and Biesse Parts.

With its global network and highly specialised team, it offers technical service and machine/component spares anywhere in the world on-site and 24/7 on-line.

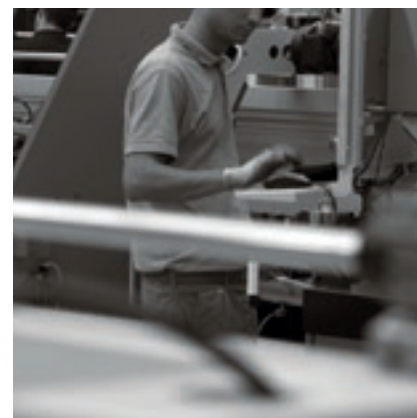

Biesse Parts

- ▶ Original Biesse spares and spare kits customised for different machine models.
- ▶ Spare part identification support.
- ▶ Offices of DHL, UPS and GLS logistics partners located within the Biesse spare part warehouse, with multiple daily pick-ups.
- ▶ Order fulfilment time optimised thanks to a global distribution network with de-localised, automated warehouses.

87% ✓ of downtime machine orders fulfilled within 24 hours.

95% ✓ of orders delivered in full on time.

100 ✓ spare part staff in Italy and worldwide.

500 ✓ orders processed every day.

Made **With** Biesse

Biesse Group technologies join forces with Lago's innovation and total quality management processes.

In the crowded world of domestic design, Lago takes its place as an emerging brand, thanks to a collection of stimulating products and a corporate philosophy that embraces the interaction between business and art, coupled with on-going research into sustainable development.

"We created a number of projects, or rather, concepts - states Daniele Lago - that have shaped Lago as we see it today: we saw design as a cultural vision that applies not only to individual products, but rather to the entire business chain".

"Flexibility is the key word here at Lago" says Carlo Bertacco, Manufacturing Manager. "We started to introduce the concept of processing only outstanding

orders, which enabled us to reduce our footprint and empty the site from the very beginning".

"The machinery that we purchased - states Bertacco - is great, it entailed a limited investment versus the capabilities it offers and is linked to a specific manufacturing approach. What I am talking about is a given manufacturing volume with Lago-standard quality levels and the possibility of customising as late as possible, at the customer's request: in short, the very basic principles of lean manufacturing".

*Source: IDM Industria del Mobile
Lago, our customer since 1999, is one of most prestigious Italian furniture brands in the world.*



<http://www.lago.it>



Biesse Group

In / 1 industrial group, 4 divisions
and 9 production sites.

How / € 14 million p/a in R&D
and 200 patents registered.

Where / 37 branches and 300
agents/selected dealers.

With / Customers in 120 countries (manufacturers of furniture,
design items and door/window frames, producers of ele-
ments for the building, nautical and aerospace industries).

We / 3,800 employees throughout the world.

Biesse Group is a multinational leader in the
technology for processing wood, glass, stone,
plastic and metal.

Founded in Pesaro in 1969, by Giancarlo Selci,
the company has been listed on the Stock
Exchange since June 2001.

 **BIESSEGROUP**

 **BIESSE**

 **INTERMAC**

 **DIAMUT**

MECHATRONICS

