

BIESSELCO SK 3

Numeric controlled panel sizing centre

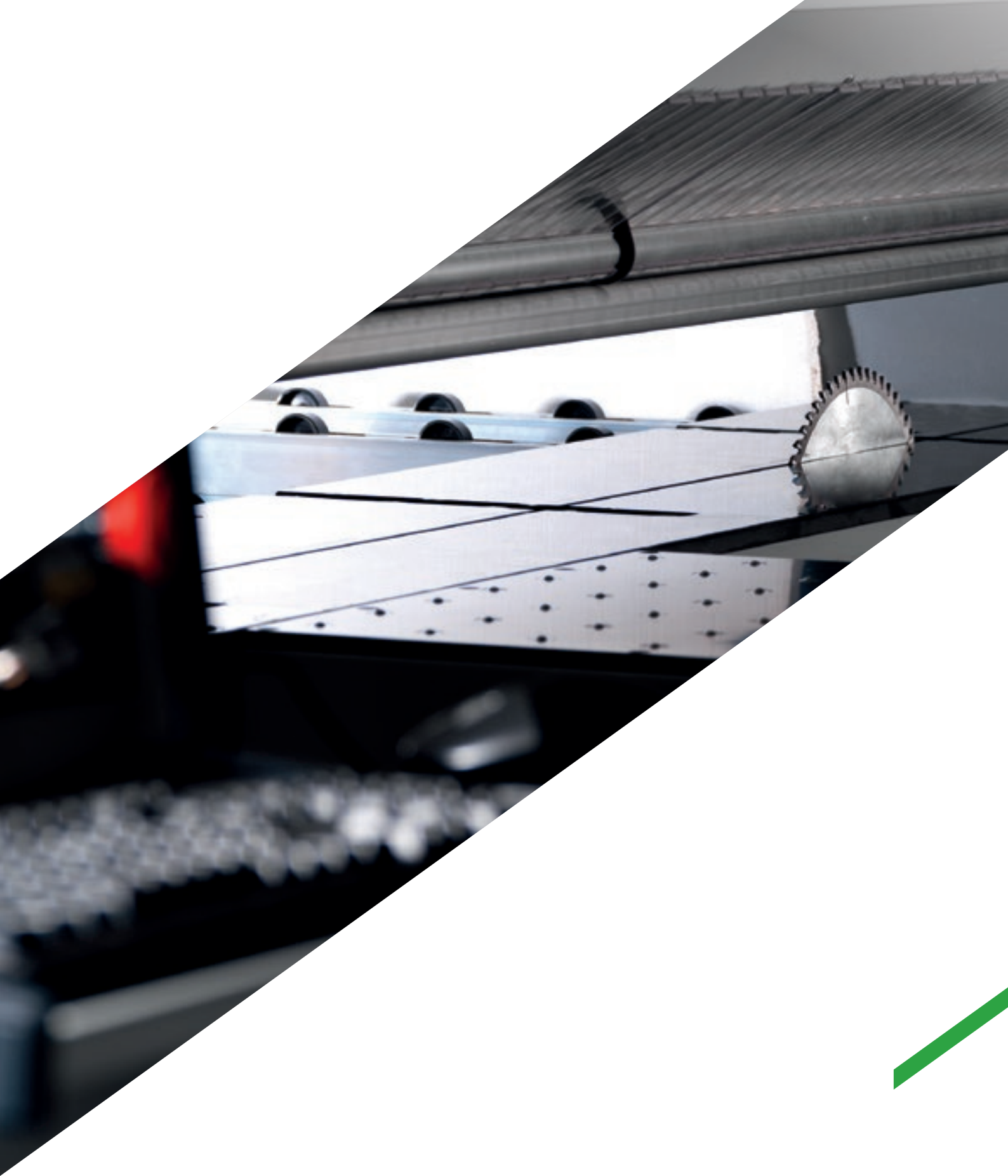

When competitiveness
means growth



Made **In** Biesse

The market demands

a change in manufacturing processes, enabling companies to accept the largest possible number of orders. This is coupled with the need to maintain high quality standards whilst offering product customisation with quick and defined delivery times.

Biesse meets these requirements

with technological solutions which enhance and support technical expertise as well as process and material knowledge. **Selco SK3** is the range of panel sizing centre able to satisfy the small and medium companies needs, because this has been specifically designed for single parts production or small series.

- 
- ✓ **Cutting accuracy.**
 - ✓ **Cycle-time reduction.**
 - ✓ **Easy and quick adjustments.**
 - ✓ **Technical solutions for the production increase..**

Easy and compact sizing



SELCO SK 3

Numeric controlled panel sizing centre

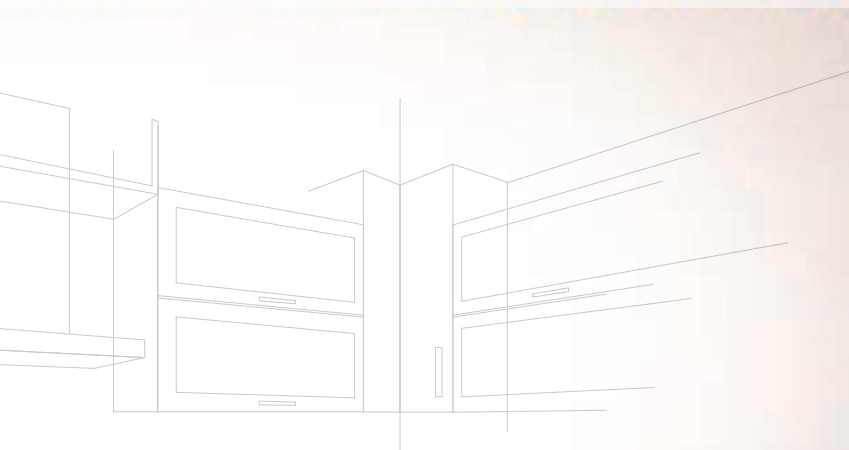

Cutting accuracy

Robust, balanced structure ensuring maximum stability. Specially-designed technologies to guarantee precision and rigidity.



The machine base consists of an heavy-duty frame structure and strong supports assuring its perfect stability. The saw carriage guideways assure perfect parallelism, rectilinearity and an optimal weight balance of the saw carriage. Additional central support for the machine of dimension 3800mm x 3800mm.

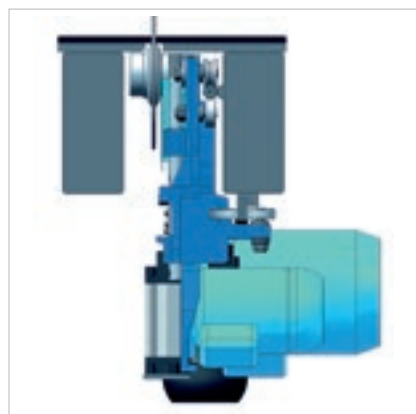

The top guide, positioned right beside the saw blade hub, guarantees the total absence of saw blade vibrations.



The extremely linear movement of the saw carriage is obtained by an helical rack and pinion system and by a brushless motor.



Independent raising and lowering of main saw blade and scoring saw blade is due to system that guarantees precision and rigidity to obtain a high cutting quality.



The pressure beam has a single structure for an even pressure on the stack of panels to be cut. The opening is automatically adjusted by the numerical control in relation to the thickness of the stack to be cut, thus obtaining the best cutting quality under any working condition. (Not available on Sektor 350).



Cycle-time reduction

Unique technical solutions to satisfy even the most rigorous production demands, in terms of processing precision and defined delivery times.

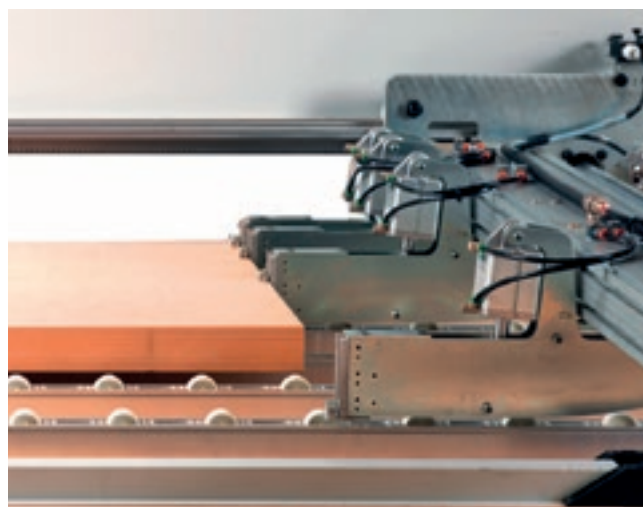

Precise and fast panel positioning thanks to the pusher carriage, driven by a brushless servomotor. The independent self-levelling grippers assure the firm clamping of the stack of panels and allow the total ejection of the stack of panel beyond the cutting line.

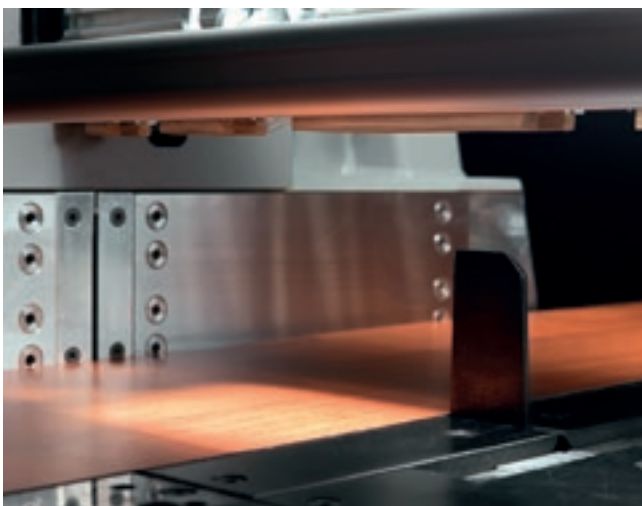

The side aligner, integrated with the saw carriage, can perfectly align even thin or flexible panels, reducing cycle cutting time.

Easy, quick adjustments

Simple technology accessible to everyone thanks to the Quick Change system (patented) for the quick release of the blades without tools.



Fast, accurate setting of the scoring and main blades, using Digiset system. The system also stores the information for each set of blades, ensuring repeatable and accurate alignment every time.

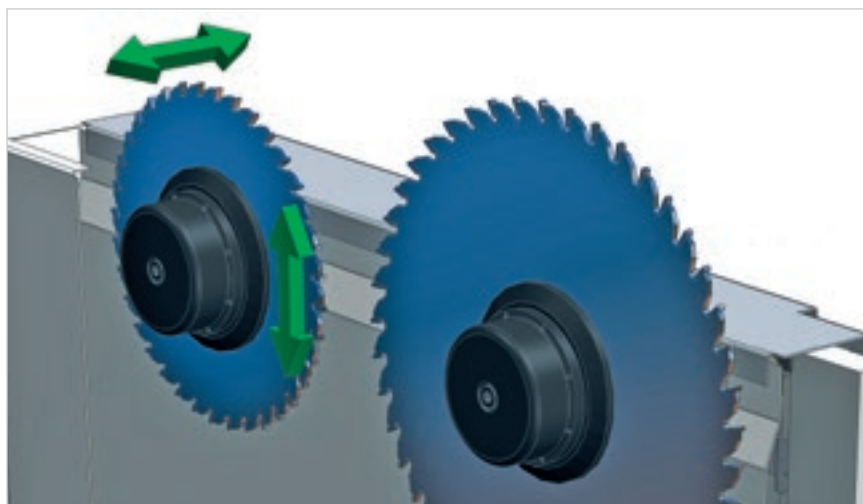

The protrusion of the main blade, and the opening of the presser, are automatically adjusted by the numerical control on the basis of the thickness of the book to be cut, thereby obtaining the best cutting quality in all working conditions.

Technical solutions for the production increase

On request special solutions are available for the movement of packs and to permit the loading and unloading of panels.



Lift table compact and integrated for automatic loading of panels, allows the loading of stacks of panels up to 500 mm directly on steel profiles.





The automatic picking of the panels is executed by the grippers according to the cutting pattern requirement. The independent self-levelling grippers assure the firm clamping of the stack of panels and allow the total ejection of the stack of panel beyond the cutting line.



Easy to use, with optimised machining operations

The **OSI (Open Selco Interface) numerical control** guarantees the management of the execution of cutting patterns, and optimizes all movements relative to controlled axis (i.e. Pusher and Saw Carriage, pressure beam, blade height). It ensures the blade protrudes from the book to the correct degree during sectioning, and calculates the most suitable cutting speed on the basis of the book height and trim cut width. It helps ensure the best cutting quality at all times.

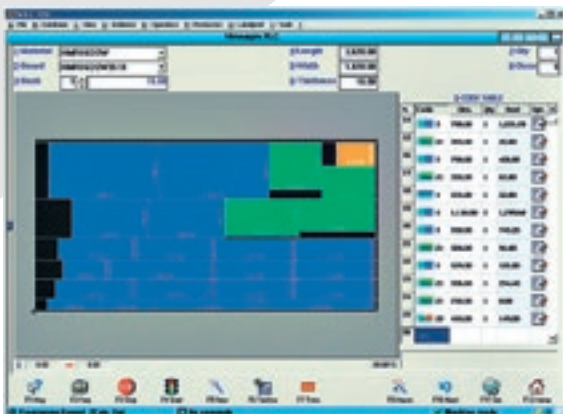

Easy cutting pattern programming.

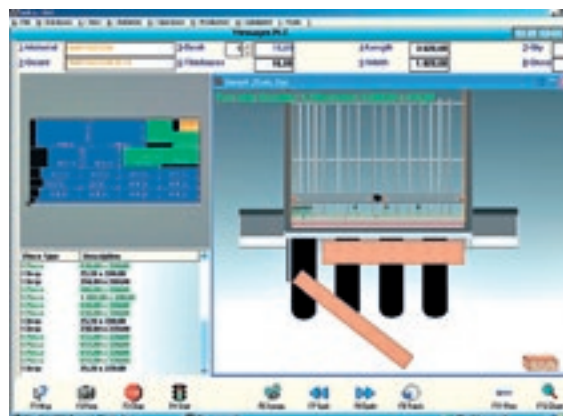

Graphic simulation in real time, with messages and information for the operator.



Interactive program for the quick, easy execution of cuts and grooves, even on recycled panels.



An effective diagnosis and troubleshooting program provides complete information (photos and text) to ensure that any problems are quickly resolved.

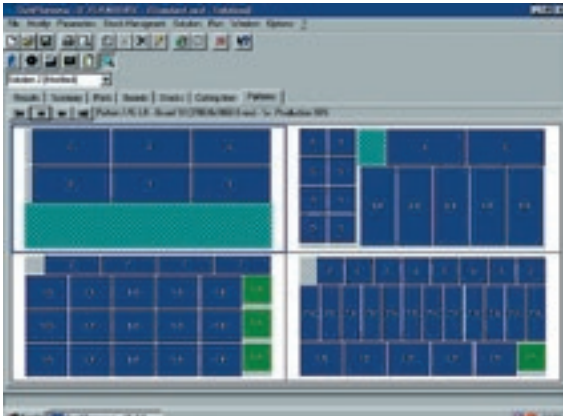

OptiPlanning

Software to optimise cutting patterns and maximise efficiency for both material costs and cutting times.

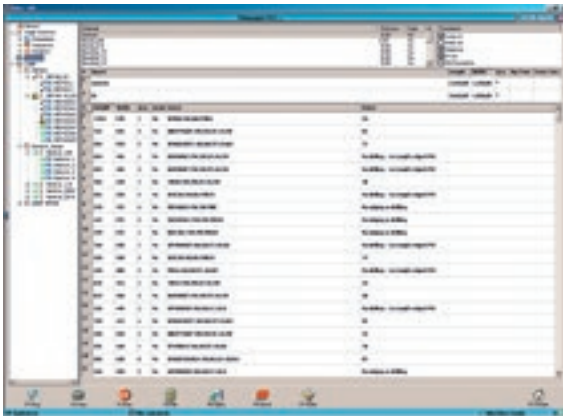

Quick Opti

Simple, intuitive software for optimising the cutting patterns directly on the machine.*



Labelling

A special software creates individual labels and prints them in real time, on the machine.



Barcode scanner

Device for automatically accessing machine operation patterns, for automated management of the remaining reusable cut material.

Technical specifications

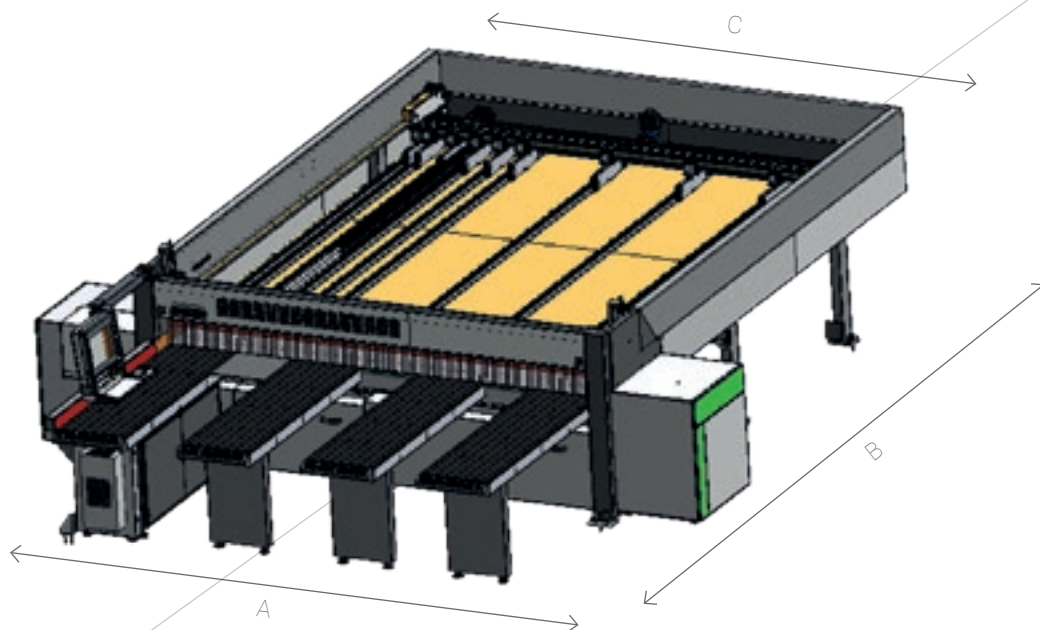

Selko SK 3

	Standard machine 3200x3200	Machine with lifting table 3800x3800
	mm	mm
A	5240	5840
B	6600	7200
C	3640	4240

	350	370
Maximum blade protrusion	75 mm - 2.92 inch	90 mm 3.54 inch
Main saw motor	7,5 kW (10 HP), 50Hz - 9 kW (12 HP), 60Hz	11 kW (15 HP), 50Hz - 13,2 kW (18 HP), 60Hz
Scoring saw motor	2,2 kW (3 HP), 50Hz - 2,6 kW (3,6 HP), 60Hz	
Saw carriage traverse movement	Brushless	
Saw carriage speed	1-120 m/min (1-394 ft/min)	
Pusher traverse movement	Brushless	
Pusher carriage speed	60 m/min (197 ft/min)	

The technical specifications and drawings are non-binding. Some photos may show machines equipped with optional features. Biesse Spa reserves the right to carry out modifications without prior notice.

A-weighted surface sound pressure level (L_{pfA}) during machining for operator workstation on vane-pump machine L_{pa}=83dB(A) L_{wa}=106dB(A) A-weighted sound-pressure level (L_{pA}) for operator workstation and sound power level (L_{WA}) during machining on cam-pump machine L_{wa}=83dB(A) L_{wa}=106dB(A) K measurement uncertainty dB(A) 4

The measurement was carried out in compliance with UNI EN 848-3:2007, UNI EN ISO 3746: 2009 (sound power) and UNI EN ISO 11202: 2009 (sound pressure levels at workstation) during panel machining. The noise levels shown are emission levels and do not necessarily correspond to safe operation levels. Despite the fact that there is a relationship between emission and exposure levels, this may not be used in a reliable manner to establish whether further measures need to be taken. The factors determining the exposure level for the workforce include length of exposure, work environment characteristics, other sources of dust and noise, etc. i.e. the number of other adjoining machines and processes. At any rate, the above information will enable the operator to better evaluate dangers and risks.

The Biesse sizing range

SINGLE-LINE BEAM SAWS



SELCO SK 3



SELCO SK 4



SELCO WN 6



SELCO WN 7

ANGLE SAWS



SELCO WNA 6



SELCO WNA 7

Service & Parts

Direct, seamless co-ordination of service requests between Service and Parts.
Support for Key Customers by dedicated Biesse personnel, either in-house and/or at the customer's site.

Biesse Service

- ✓ Machine and system installation and commissioning.
- ✓ Training centre dedicated to Biesse Field engineers, subsidiary and dealer personnel; client training directly at client's site.
- ✓ Overhaul, upgrade, repair and maintenance.
- ✓ Remote troubleshooting and diagnostics.
- ✓ Software upgrade.

500 / Biesse Field engineers in Italy and worldwide.

50 / Biesse engineers manning a Teleservice Centre.

550 / Certified Dealer engineers.

120 / Training courses in a variety of languages every year.

The Biesse Group promotes, nurtures and develops close and constructive relationships with customers in order to better understand their needs and improve its products and after-sales service through two dedicated areas: Biesse Service and Biesse Parts.

With its global network and highly specialised team, it offers technical service and machine/component spares anywhere in the world on-site and 24/7 on-line.



Biesse Parts

- ✓ Original Biesse spares and spare kits customised for different machine models.
- ✓ Spare part identification support.
- ✓ Offices of DHL, UPS and GLS logistics partners located within the Biesse spare part warehouse, with multiple daily pick-ups.
- ✓ Order fulfilment time optimised thanks to a global distribution network with de-localised, automated warehouses.

87% / of downtime machine orders fulfilled within 24 hours.

95% / of orders delivered in full on time.

100 / spare part staff in Italy and worldwide.

500 / orders processed every day.

Made **With** Biesse

Biesse technology accompanies the growth of Stechert

"On these chairs sits the world" is the motto of the Stechert Group that can effectively be taken literally. What began 60 years ago as a small manufacturing company for pram mouldings, furniture doors and door locks is today one of the largest international suppliers of contract and office chairs, as well as tubular steel furniture. Moreover, since 2011 the company has a partnership with WRK GmbH, an international specialist in podiums, conference room and grandstand seating, associated with Stechert via the joint commercial company STW.

For Stechert management, however, the excellent results obtained are no excuse for resting on their laurels. On the contrary, the company is investing heavily in the Trautskirchen site to make its production even more efficient and profitable. In the search for a new machinery partner, the company's management chose the Italian manufacturer Biesse. "For the project we chose machines that already had certain options and were predisposed for automation", said

Roland Palm, Biesse Area Manager. An efficient production cycle was created in which workers are able to perform at their best after only a short training period. At the start of the production line is the panel saw "WNT 710" with one cutting line. "Because", explained skilled cabinet maker Martin Rauscher, "we want to be able to work panels of up to 5.90 metres in order to reduce waste as much as possible." Normal rectangular panels for tables or wall panels are taken directly to the "Stream" edgebander with "AirForceSystem" technology. The Biesse edgebander has a group that activates the laminated edging material no longer via a laser beam but using hot air to obtain the so-called "zero gap". "The quality is just as good as the laser system, if not even better: with a connection power of 7.5 kW, the cost per square metre is much lower", underlined the Biesse Area Manager. "We want to be ready for when we mould the frame ourselves and we must therefore calibrate the panels" said Martin Rauscher, "The same is true of course

for solid wood and multiplex panels, which require grinding before being painted in an external company. For both types of work a Biesse "S1" sander is used. In order to meet the needs of the future, in the Trautskirchen plant there are also two Biesse numerically controlled machining centres: a "Rover C 965 Edge" and a "Rover A 1332 R", which are perfectly complementary.

The Stechert Group also intends to strengthen sales of innovative solutions for interior fittings with complete systems for walls, ceilings, floors and mezzanines. For panel cutting, the Group has purchased a "Sektor 470". For other geometry, groove and spring machining as well as boring and surface milling, there are two Biesse machining centres, an "Arrow" for nesting applications, a "Rover B 440" and more recently a 5-axis machine, the "Rover C 940 R" machining centre in order to be able to produce, in particular, wall and ceiling panels machined in 3 dimensions.

Source: HK 2/2014



<http://www.stechert.de>



Biesse Group

In

1 industrial group, 4 divisions and 8 production sites.

How

€ 14 million p/a in R&D and 200 patents registered.

Where

33 branches and 300 agents/selected dealers.

With

customers in 120 countries, manufacturers of furniture, design items and door/window frames, producers of elements for the building, nautical and aerospace industries.

We

3,000 employees throughout the world.

Biesse Group is a multinational leader in the technology for processing wood, glass, stone, plastic and metal.

Founded in Pesaro in 1969, by Giancarlo Selci, the company has been listed on the Stock Exchange (STAR segment) since June 2001.

 **BIESSEGROUP**

 **BIESSE**

 **INTERMAC**

 **DIAMUT**

MECHATRONICS

