

HPP
HPL
HPV

11

Optimal planen –
perfekt sägen

Optimum planning –
perfect sizing

Planning optimum –
débit parfait

Planear óptimamente –
cortar perfectamente

Progettare in modo
ottimale – sezionare in
modo perfetto

Ihr Anspruch auf höchste Qualität.

Doppelseitige, automatische Winkel-
andrückvorrichtung.
Postformingschnitte im Durchlauf.
Gehrungsanschlag mit digitaler Anzeige.
Automatisches Nuten und Falzen.

Automatic side pressure device on both
sides of the cutting line.
Continuous cutting of postformed parts.
Mitre fence with LED.
Automatic grooving and rebates.

Dispositif d'équerrage automatique des
deux côtés de la ligne de coupe.
Coupe postformé au défilé.
Règle d'angle avec indication numérique.
Rainure et feuillure en automatique.

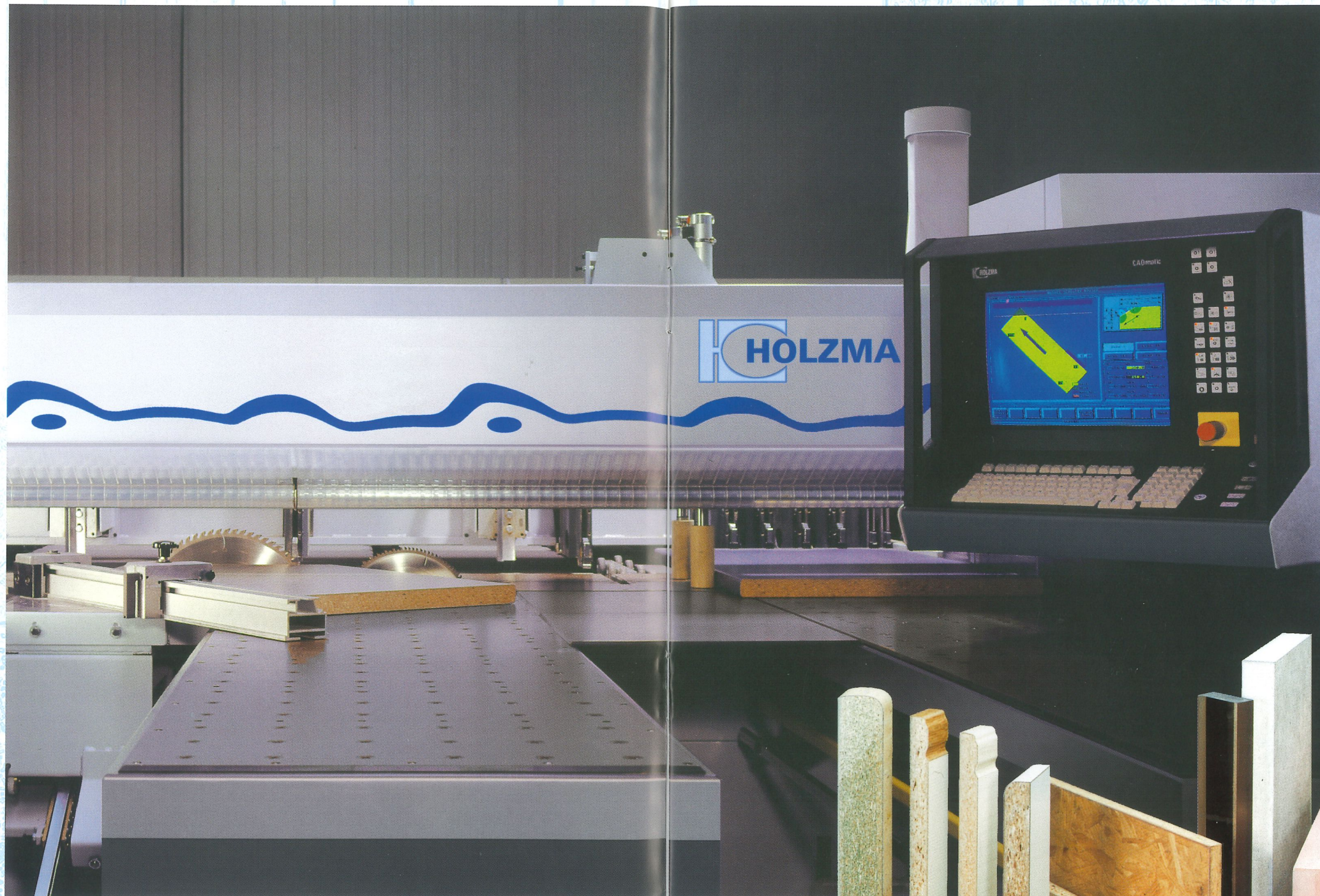

Dispositivo de presión angular auto-
mático, en ambos lados de la línea de
corte.
Cortes de postforming en continuo.
Regla de inglete con indicación digital.
Ranurar y rebordear automáticamente.

Dispositivo automatico doppio per la
pressione angolare.
Tagli postforming in continuo profiles.
Registro inclinato con indicazione digitale.
Esecuzione di scanalature e battute in
automatico.

Your demand for best quality.

Vos exigences pour une qualité au plus
haut niveau.

Su exigencia de una calidad máxima.

Le Vostre esigenze con la massima
qualità.



Erfolg wird berechenbar – reduzieren Sie Ihre Kosten im Plattenzuschnitt.

Entscheiden Sie sich für HOLZMA- Technik ohne Kompromisse!

Maßgenauer Fertigschnitt.
Perfekte Schnittqualität für alle Plattenmaterialien.
Überlegene CNC-Steuerung.
Lineares Mess-System.
Speziell für Handwerk, Innenausbau, Möbelfertigung, Objektbau.

Without compromise!

Accurate dimensions.
Perfect cut quality.
User-friendly CNC control system.
Non-contact, linear measuring system.
Ideal for custom work, fabrication and all types of furniture production.

Optez pour la technique HOLZMA sans compromis!

Précision de coupe finie.
Qualité de coupe parfaite.
Commande numérique CADmatic supérieure.
Système de mesure linéaire.
Adaptée à l'artisanat, l'agencement, la fabrication de meubles.

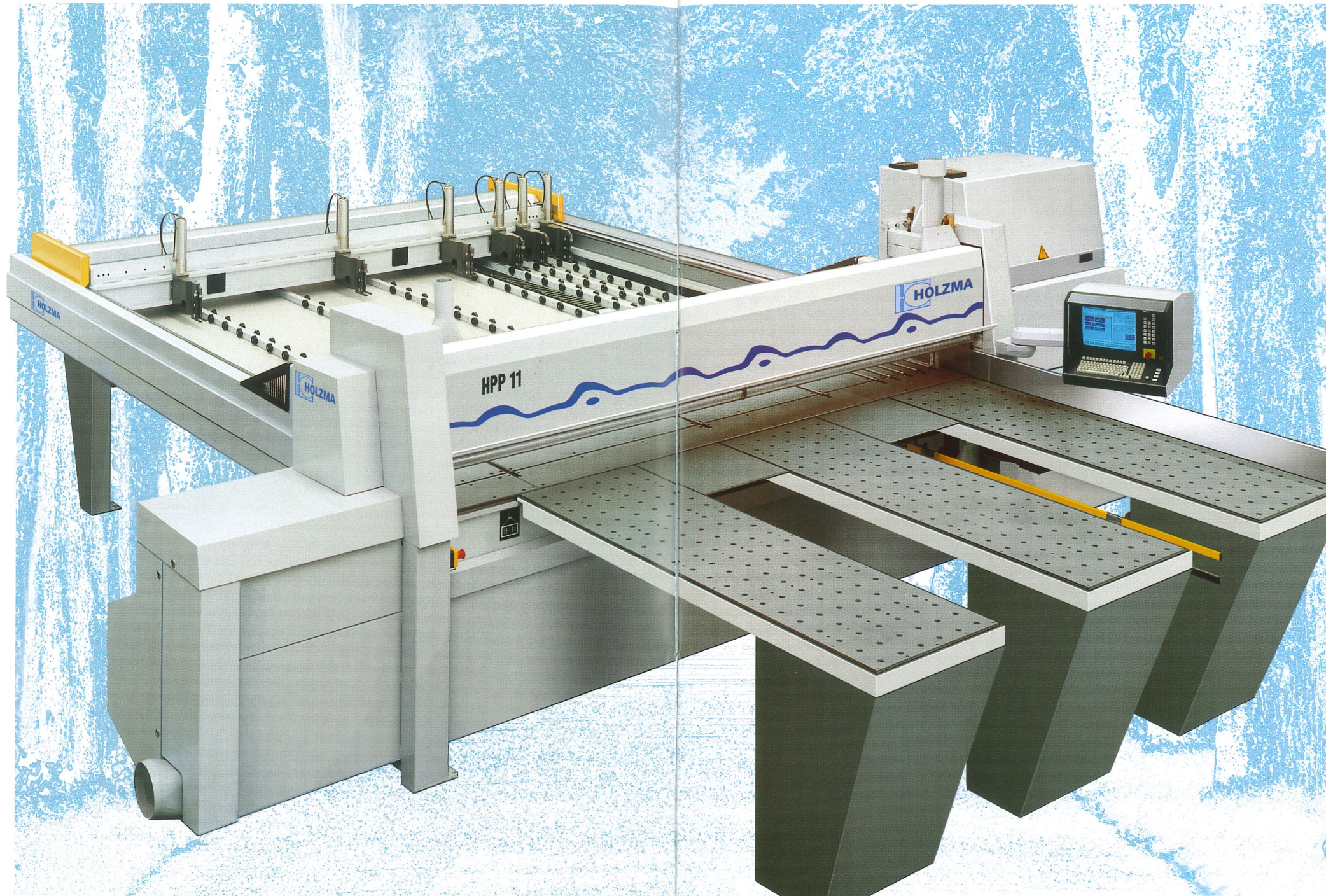
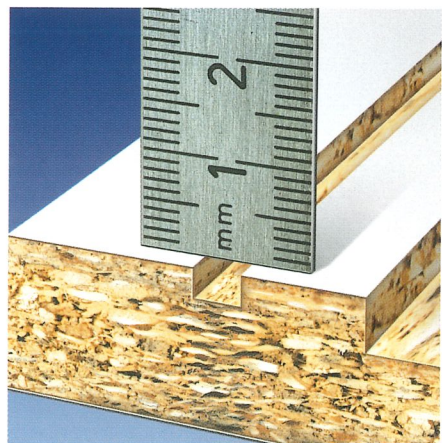

Complázcase Ud. y compre la tecnología HOLZMA.

Corte exacto medida final.
Gran calidad de corte.
Tecnología de control numérico de fácil manejo.

Sistema de medida lineal.
Especial para artesanía, arquitectura de interiores y muebles.

Automatisches Nuten und Falzen.
Automatic grooving and rebates.
Rainure et feuillure en automatique.
Ranurar y rebordar automáticamente.
Ejecución automática de scanalature e battute.

Success becomes evident –
reduce your costs for cut-to-size.

Le succès peut être évalué – réduisez
vos coûts dans le débit des panneaux.

El éxito será calculable –
reduzca sus gastos en el corte del tablero.

Il successo diventa valutabile – ridurrete
i costi per la sezionatura dei pannelli.

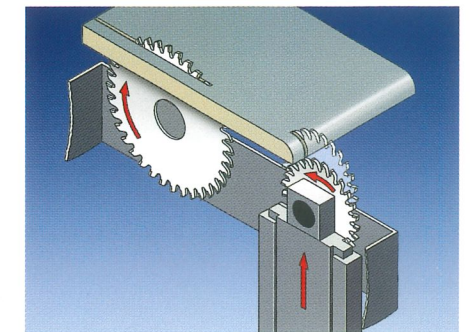

Aufsteigende Vorritzsäge zum
ausrissfreien Ablängen von Post- und
Softformingteilen.

Jump-up scoring saw for chipfree
cross-cutting of post- and softformed
edges.

Inciseur remontant pour la découpe
sans éclat de pièces postformées et
softformées.

Sierra incisora ascendente para
cortar en longitudinal y sin astillar piezas
postformadas y softformadas.

Incisore che si solleva verso l'alto
per tagliare senza scheggiature pezzi
post e softforming.

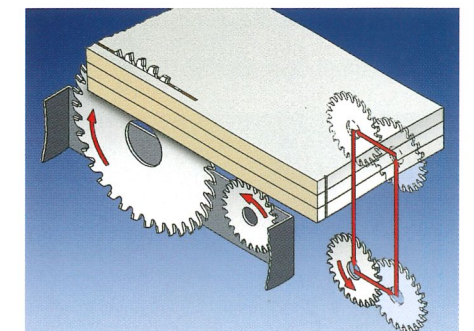

Vertikale Vorritzsäge zum
ausrissfreien Ablängen von Streifen-
paketen.

Vertical scoring saw for chipfree
cross-cutting of books of strips.

Inciseur vertical pour la découpe
des paquets de bandes.

Sierra incisora vertical para
cortar en longitudinal y sin astillar los
paquetes de tiras.

Incisore verticale per tagliare senza
scheggiature pacchi di barre.

Scegliete la tecnica HOLZMA senza compromessi.

Taglio finito di precisione.
Perfetta qualità di taglio.
Impiego universale per ogni tipo di
pannelli.

Sistema di misura lineare.
Speciale per l'artigianato, l'arreda-
mento d'interni, la produzione di mobili
e l'oggettistica.

Anwendungen – so vielfältig wie die Praxis.

Einzelzuschnitte.
Single cuts.
Coupe à l'unité.
Corte individual.
Taglio individuale.

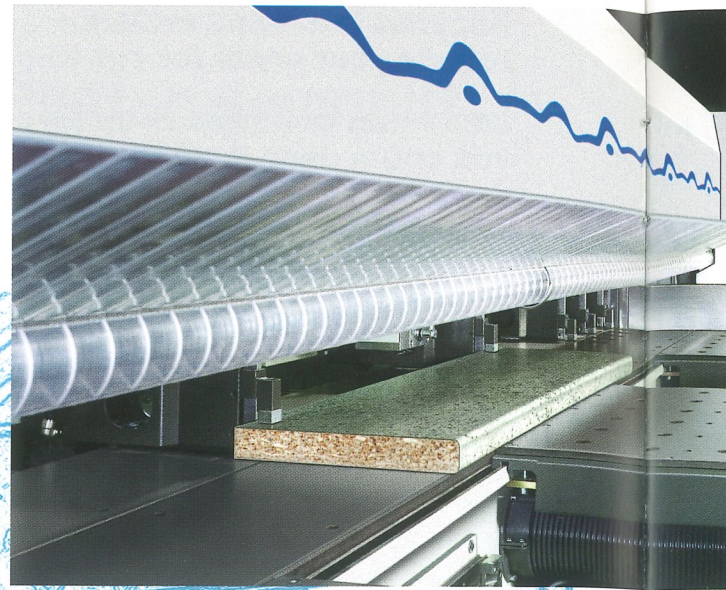

Applications as versatile as required
by practical needs.

Aplicaciones múltiples cuando
la práctica lo solicita.

Utilisation – universelle comme il se doit.

Utilizzi molteplici come in pratica.

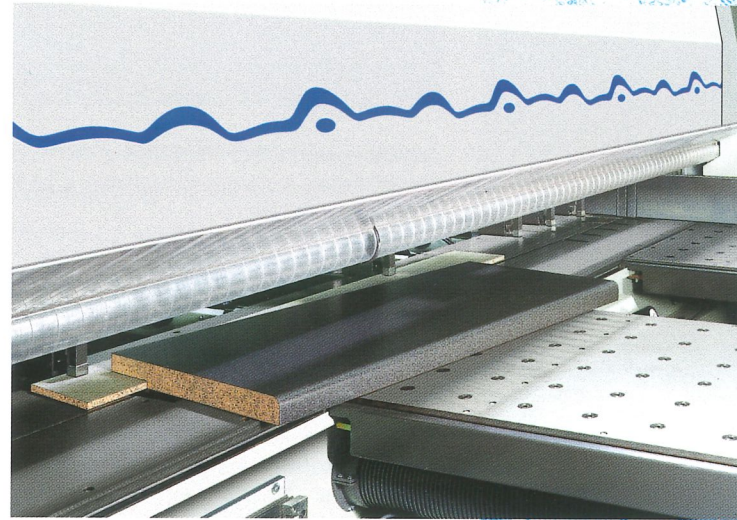

Schrägschnitte mit Schablone.
Cutting angles with template.
Coupes d'angles au gabarit.
Trabajar con platilla.
Tagli inclinati con sciablone.



Überstehende Furniere oder Laminat.
Projecting veneers or laminates.
Placages ou stratifiés débordants.
Chapas o laminados sobresalientes.
Impiallacciatura o laminato sporgenti.

Gehrungsanschlag.
Mitre fence.
Règle d'angle.
Regla de inglete.
Registo inclinato.

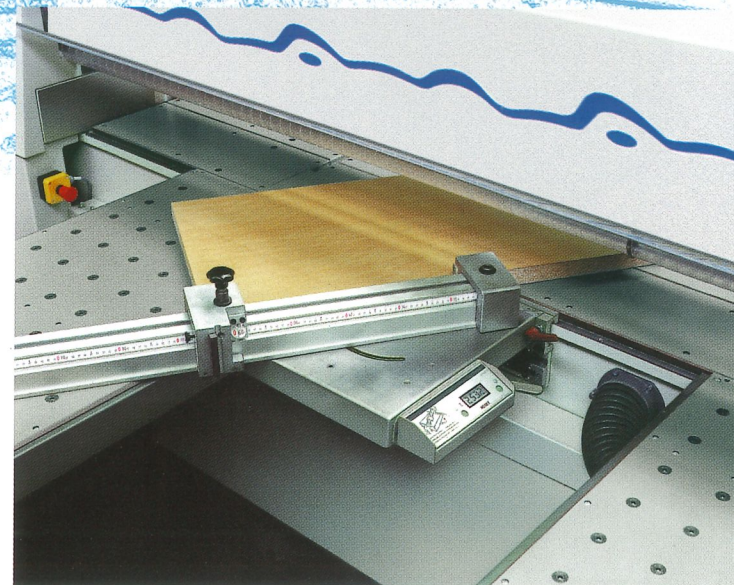

Massivholzzuschnitt mit Laserrichtlicht
und Anschläge für Schnitautomatik.

Laser light for solid wood and pushers
for continuous ripping.

Trait d'ombre à laser pour bois massif
et butées pour la découpe automatique.

Alineador del rayo laser para maderas
macizas y topes para el corte automático.

Taglio di masselli con raggio laser e
registri per il taglio automatico.

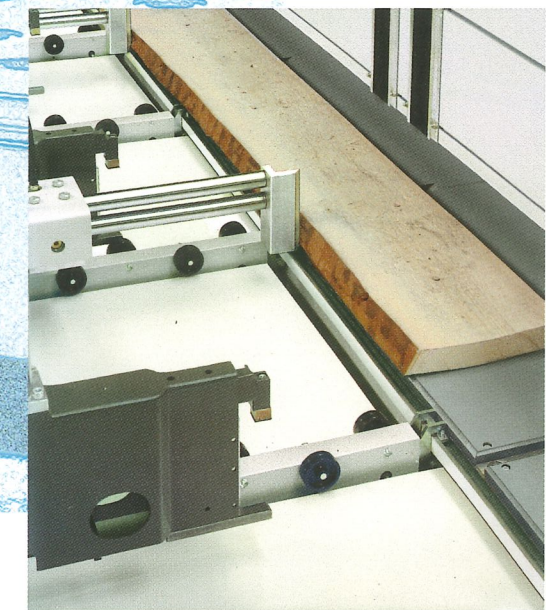
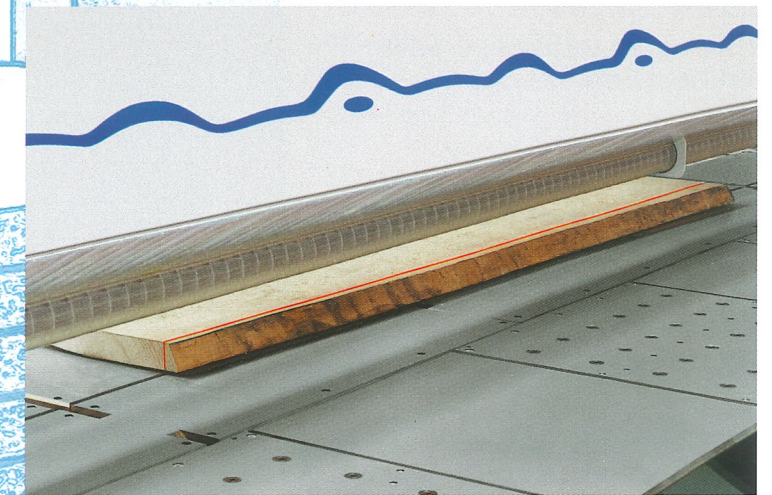
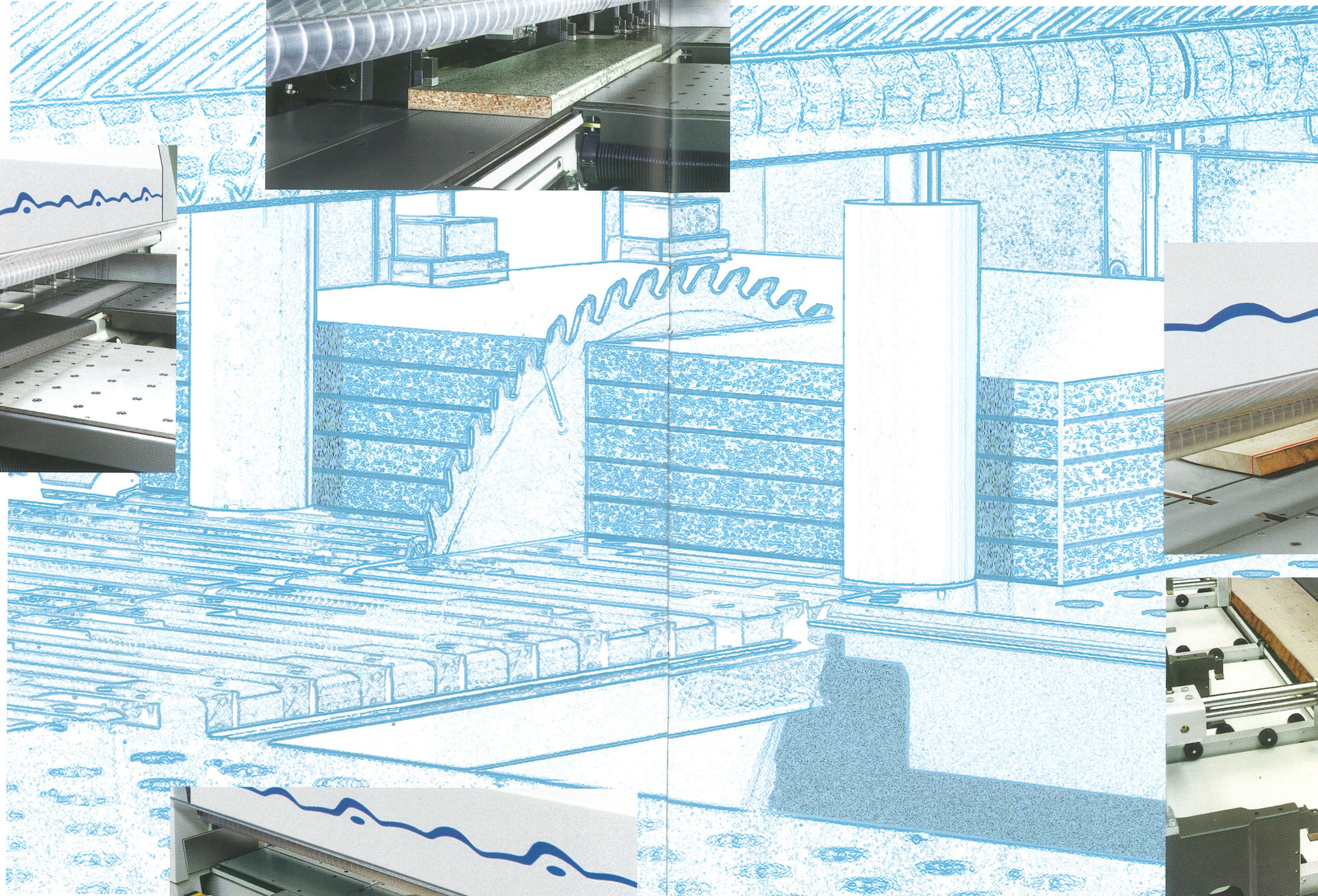

Steigern Sie Ihre Leistung im Plattenzuschnitt mit vollautomatischer Beschickung.

Entscheiden Sie sich für eine Investition ohne Abenteuer!

Hydraulischer 4-Säulen-Hubtisch.

Mikro-Einschübe für dünne, wellige Platten.

Wahlweise Vorstapeltisch für Fremdbeschickung.

Wahlweise Drehvorrichtung für Kopfschnitte im Maschinentisch.

Wahlweise Drehvorrichtung an der Maschinenvorderseite.

Handling und Ergonomie für echte Ein-Mann-Bedienung.

Production performance makes this model the ideal investment for the future.

Hydraulic 4-column lift table.

Micro infeed units for thin, wavy panels.

Preparation table for external feeding as option.

Automatic turning device for head cuts at the machine table as option.

Automatic turning device at the front of the machine as option.

Handling and ergonomics for genuine one-man-operation.



Increase your performance in cut-to-size with most fully automatic feeding.

Augmentez les capacités dans le domaine du débit grâce à l'alimentation entièrement automatique.

Aumente su potencia en el corte de tablero por una alimentación completamente automática.

Con il caricatore completamente automatico incrementerete il rendimento della sezionatura dei pannelli.

Optez pour un investissement sans aventures!

Table élévatrice à 4 colonnes.

Micro-alimentateur pour panneaux minces et ondulés.

Possibilité de table de pré-charge pour alimentation étrangère.

Possibilité d'une table de retournement dans la table machine pour traiter les coupes de tête.

Possibilité d'une table de retournement à l'avant de la machine.

Utilisation et ergonomie étudiée pour le conducteur de machine.

Scegliete un investimento senza sorprese.

Elevatore idraulico a 4 colonne.

Microintroduttori per pannelli sottili e ondulati.

A scelta tavolo di preaccatastamento per caricatori non Holzma.

A scelta dispositivo di rotazione per tagli di testa sul tavolo della macchina.

A scelta dispositivo di rotazione sul lato anteriore della macchina.

Utilizzo e forma ergonomica per 1 solo operatore.

Decídase por una inversión sin riesgos!

Mesa elevadora hidráulica con 4 columnas.

Micro-alimentadores para tableros delgados y ondulados.

Opcionalmente mesa pre-apiladora para alimentación externa.

Opcionalmente dispositivo de giro para cortes de cabeza en la mesa elevadora.

Opcionalmente dispositivo de giro en la parte delantera de la máquina.

Manejo y utilización adaptado para una persona.

Individuelle Plattenbeschickung für alle Materialien.

Beschickung eines Plattenpakets.

Infeed of a book of panels.

Alimentation d'un paquet de panneaux.

Alimentación de paquetes de tableros.

Carico di un pacco di pannelli.

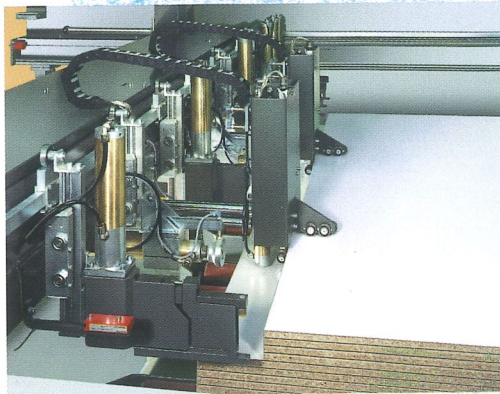

Mikro-Einschübe für den paketweisen Einschub dünner Platten.

Micro-infeeds for feeding thin and wavy panels.

Micro-alimentateurs pour l'alimentation de panneaux minces en paquets.

Micro-alimentadores para la alimentación de paquetes de tableros delgados.

Microintroduttori per pacchi di pannelli sottili.

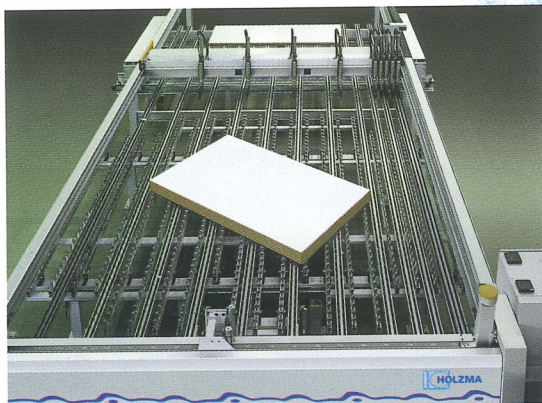

Drehvorrichtung für Kopfschnitte.

Turning device for head cuts.

Dispositif de retournement pour coupes de tête.

Dispositivo de giro para cortes de cabeza.

Dispositivo di rotazione per tagli di testa.

ECONOLIFT

Automatischer Einschub an der Maschinen-Vorderseite.

Automatic feeding unit at front of machine.

Alimentation automatique par l'avant de la machine.

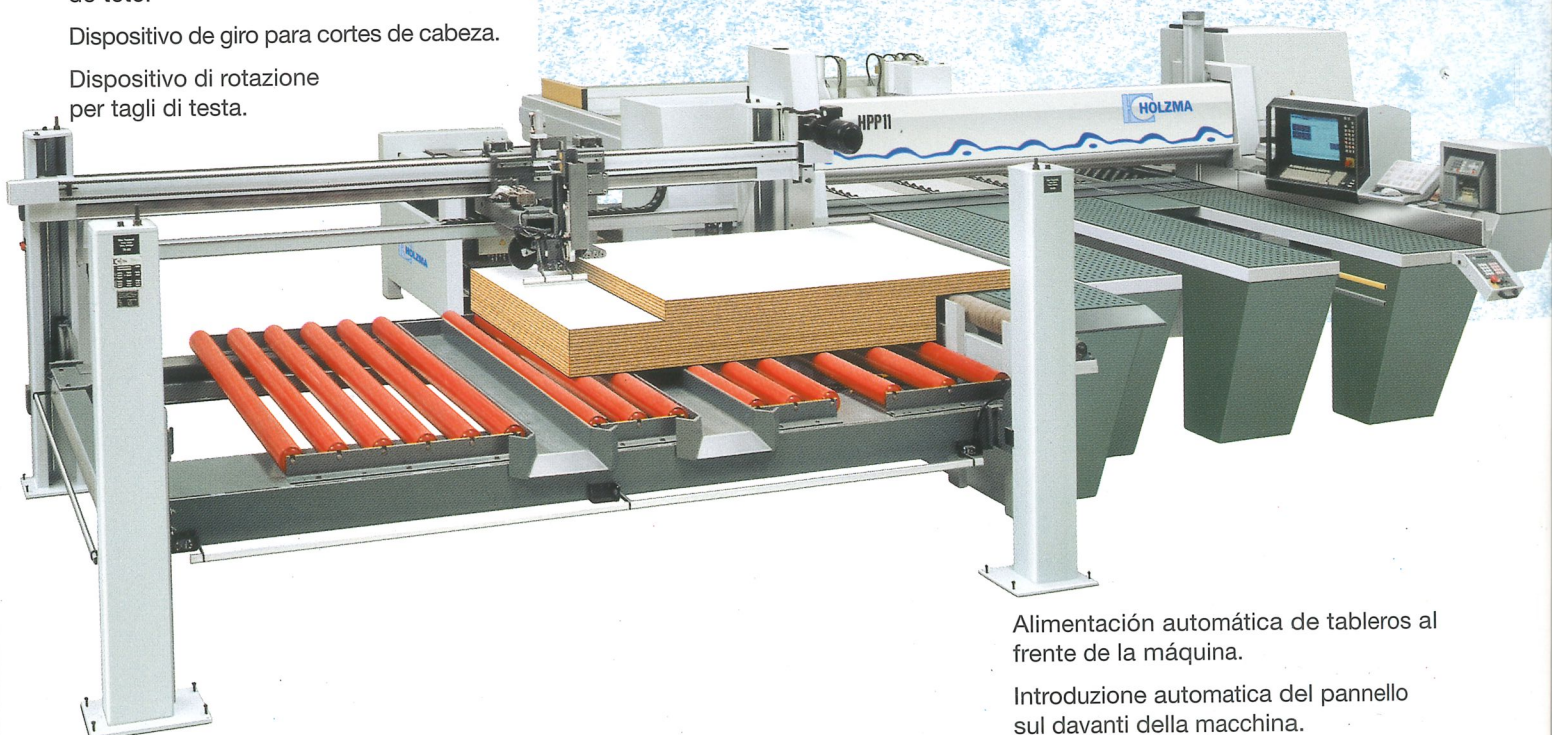

Alimentación automática de tableros al frente de la máquina.

Introduzione automatica del pannello sul davanti della macchina.

Individual feeding for all kind of panels.

Alimentation de panneaux personnalisée selon tous types de matériaux.

Alimentación de tableros, individual para todo tipo de material.

Alimentazione pannelli individuale per ogni tipo di materiale.

Vakuumbeschickung:

Vacuum feeding:

Alimentation avec traverses à ventouses:

Alimentación con ventosas:

Alimentazione con traverse a ventose:

... für dünne Platten.

... for thin panels.

... pour panneaux minces.

... para tableros delgados.

... per pannelli sottili.



Vereinzelung der Platten durch ein Spezial-Vakuüm-System.

Separation of panels by special vacuum system.

Décollage des panneaux grâce à un système spécial à ventouses.

Separación de los tableros mediante sistema especial de ventosas.

Singolarizzazione dei pannelli con sistema a depressione speciale.

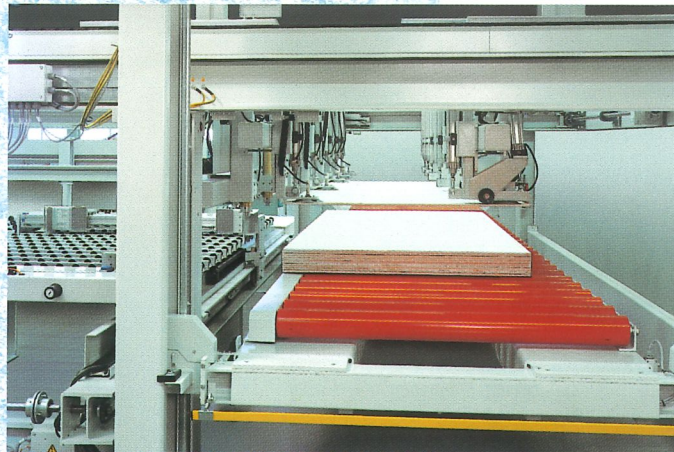

Hochleistungsbeschickung von Einzelplatten.

High performance feeding system for single panels.

Haut niveau de performances pour l'alimentation de panneaux unitaires.

Alimentación de alto rendimiento de tableros individuales.

Caricatore ad alto rendimento per pannelli singoli.



Vorstapeltisch mit automatischer Längs- und Querausrichtung.

Prestacking table with automatic length and cross alignment.

Table d'empilage avec dispositif automatique pour le cadrage en sens longitudinal et transversal.

Mesa pre-estibadora con alineación automática en el sentido longitudinal y transversal.

Tavolo di preaccatastamento con allineamento longitudinale e trasversale automatico.

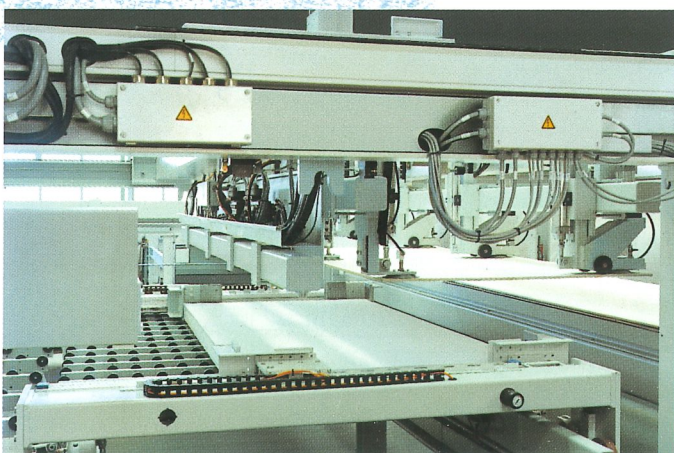

Die Systemreihe 11, im Einklang mit der Praxis



Freie Zugänglichkeit für Wartung und Sägeblattwechsel • Haupt- und Vorritzsäge, doppelseitige Vertikalführung • Schnellspannvorrichtung • Schnittlängenautomatik.

Free access for maintenance and change of saw blades • Linear, double side guide system for main and scoring saw • Quick blade change • Automatic cutting length adjustment.

Accès facile pour entretenir et changer les lames de scie • Scie principale et inciseur, guide parallèle • Changement rapide des lames • Limitation automatique de la longueur de coupe.

Cómodo acceso al carro de sierra para el mantenimiento y cambio de las hojas • Sierra principal e incisora, guías paralelas • Dispositivo de sujeción rápida • Limitación automática de la longitud de corte.

Libero accesso per manutenzione e cambio delle lame • Lama principale e incisore, guida verticale doppia • Dispositivo di fissaggio rapido • Dispositivo automatico per la lunghezza di taglio.

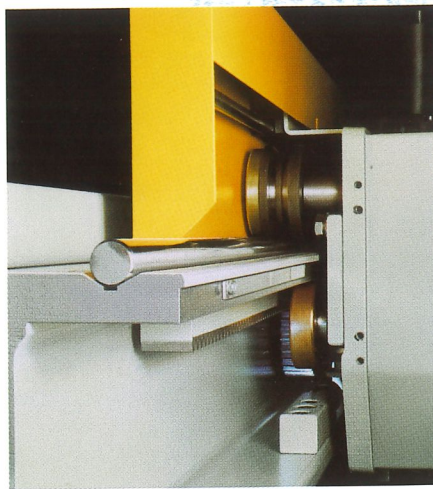

Präzise, doppelseitige Programmschieberführung • Wartungsfreie Prismenrollen • Berührungsfreies Linear-Mess-System.

High precision guide system of program fence, on both sides • Maintenance free prismatic rollers • Non-contact, linear measuring system.

HPP 11	A	B	C
3200	5684	3710	7036
3800	6244	4270	7596
4300	6834	4860	8186
5600	8184	6210	9536

HPL 11	A	B	C
3200 x 1600	5682	3710	13406
3200 x 2200	5684	3903	10140
3800 x 2200	6244	4483	10690
4300 x 2200	6834	4903	11240
5600 x 2200	8184	6403	12490

HPV 11	A	B	C
3200 x 1600	5682	3710	13406
3200 x 2200	5682	3710	14056
3800 x 1600	6242	4270	14056
3800 x 2200	6242	4270	14606
4300 x 2200	6832	5452	15156
5600 x 2200	8185	6210	16392

Guide du poussoir programmé double et précis • Galets prismatiques sans entretien • Système de mesure linéaire, sans contact.

Guía de precisión bilateral del posicionador de programa • Ruedas prismáticas sin mantenimiento • Sistema de medida lineal, sin contacto.

Guida di precisione doppia dello spingitore a programma • Rulli prismatici senza manutenzione • Sistema di misura lineare senza contatto.

The machine series of the type 11,
matching all practical requirements.

La série 11, est en
harmonie avec la pratique.

La serie 11, corresponde
a sus requerimientos prácticos.

La serie 11, risponde
perfettamente a tutte le esigenze pratiche.

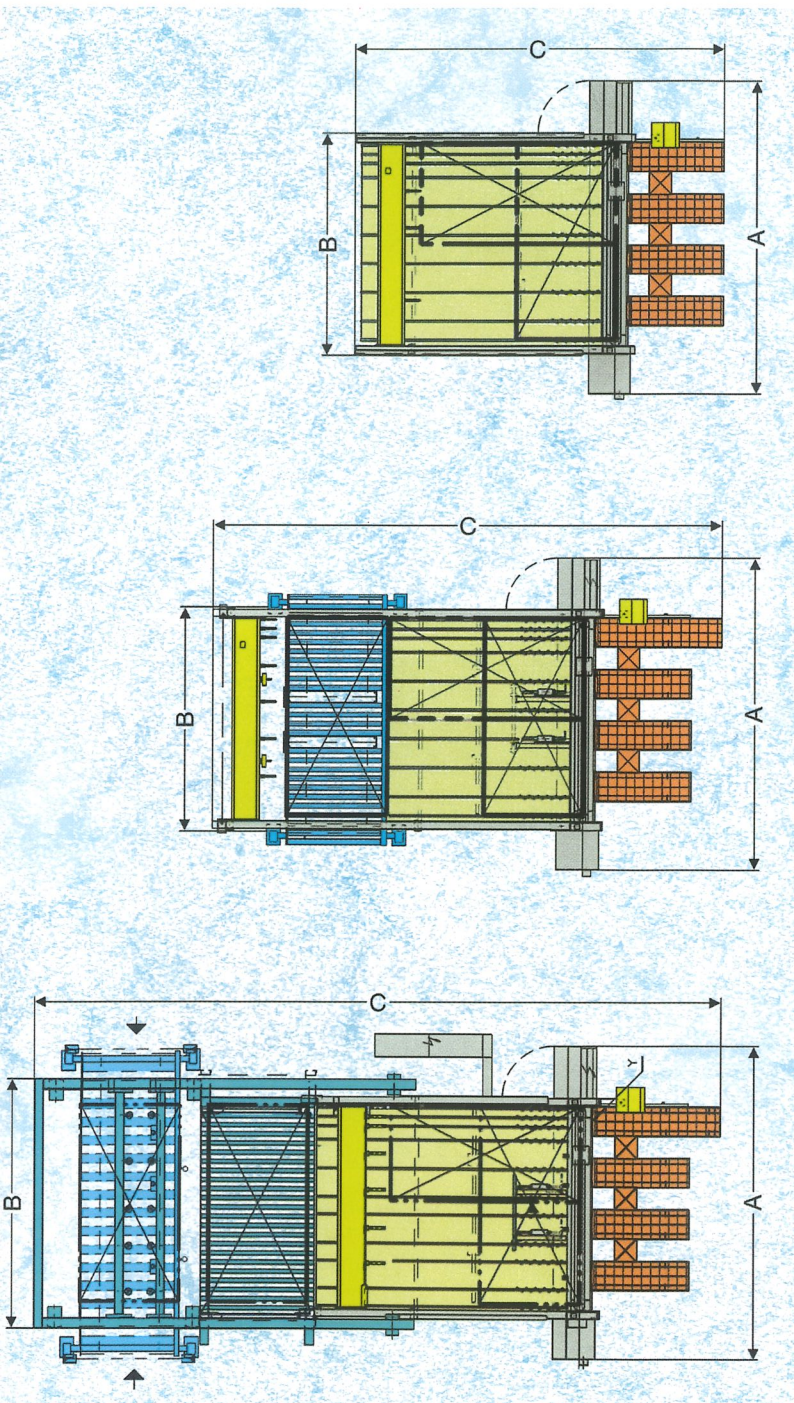

	HPP 11	HPL 11	HPV 11
Sägeblattüberstand Saw blade projection Dépassement de lame de scie Saliente de sierra Sporgenza della lama	125 mm		
Schnittlänge Cutting length Longueur de coupe Longitud de corte Lunghezza di taglio	3200/3800/4300/5600 mm		
Max. Plattenbreite für Lift/VAC Max. board width for lift Largeur max. de panneaux pour table élévatrice Ancho max. de las placas para mesa elevadora Larghezza max. del pannello per elevatore	1600/2200 mm		
Max. Stapelhöhe ohne Grube Max. stack height without pit Hauteur max. de pile sans fosse Altura max. de la pila sin foso Altezza max. catasta senza fossa	690 mm	900 mm	
Max. Stapelhöhe mit Grube Max. stack height with pit Hauteur max. de pile avec fosse Altura max. de la pila con foso Altezza max. catasta con fossa	1200 mm		
Max. Stapelgewicht Max. load Charge max. Carga max. Peso max. catasta	7 to (14 to)		
Hauptsägemotor Main saw motor Moteurs scies principales Motores sierras principales Motori lama principale	13,5/18,0 kW (18,0/25,0 HP)		
Vorritzsägemotor Scoring saw motor Moteurs scies inciseurs Motores sierras incisoras Motori incisori	2,2 kW/3,0 HP		
V= Sägewagen Saw carriage speed Vitesse chariot porte-scie Avance carro de sierra Velocità carrello sega	10 - 125 m/min max.		
V= Programmschieber Program fence Pousseur programmé Posicionador de programa Spingitore a programma	10 - 80 m/min max.		
Gesamtluftbedarf bei 6 bar Total air volume based upon 6 bar Débit d'air total basé sur 6 bar Consumo de aire total con 6 bar Fabbisogno compl. aria a 6 atm	30 l/min	140 l/min	
Erforderlicher Luftdruck Air pressure required Pression d'air nécessaire Presión de aire necesaria Fabbisogno aria compressa	6 bar		
Gesamtelektrischer Anschlusswert Total connected load Puissance totale Consumo nominal total de corriente Valore compl. di collegamento el.	26 kW	35 kW	45 kW
Absaugung Extraction Aspiration Aspiración Aspirazione	5000 m ³ /h – 26 m/sec		

Modernste Steuerung im Datenverbund vom Zuschnitt bis zu Ihrer Endmontage.

CADmatic

Bedienerfreundlich, Ablaufgrafik, Fehlerdiagnose.

Easy to handle, moving graphics, error diagnostics.

Manupulation facile, diagramme de déroulement, diagnostic d'erreurs.

Fácil manejo, visualización gráfica, diagnóstico de fallos.

Utilizzo facile, grafica del ciclo, diagnosi guasti.



CADmatic

Datenverbund Online -

die perfekte Verbindung mit dem HOLZMA-Zuschnitt-Optimierungsprogramm «Schnitt-Profi(t)». **CADplan**, die Zuschnitt-Optimierung als Option in der **CADmatic**-Steuerung.

Online capability -

the perfect link to "Cut Rite", the optimization program from HOLZMA. As an option, **CADplan** - the optimization program - built into the **CADmatic** machine control.

Liaison Online -

Communication parfaite et directe avec le programme d'optimisation de coupe HOLZMA «Profi(t)-Coupe» au P.C. de bureau. En option la commande **CADmatic** avec **CADplan**, c'est l'optimisation de coupe intégrée dans la commande de la machine.

Conexión Online -

la unión perfecta con el programa de optimización HOLZMA «Corte Optimo». **CADplan**, la optimización de corte como alternativa en el mando **CADmatic**.

Collegamento online -

il collegamento perfetto con il sistema di ottimizzazione del taglio HOLZMA «Schnitt-Profi(t)». **CADplan**, ottimizzazione del taglio come opzione nel comando **CADmatic**.



HOLZMA

HOLZMA

Most modern controls including data transfer from cut-to-size up to assembly.

La commande la plus moderne avec liaison des données en partant de la découpe jusqu'au montage.

Controles más moderno con transferencia de datos de corte hasta el montaje final.

Commandi dell'ultima generazione con collegamento on-line fino al Vostro reparto di montaggio.

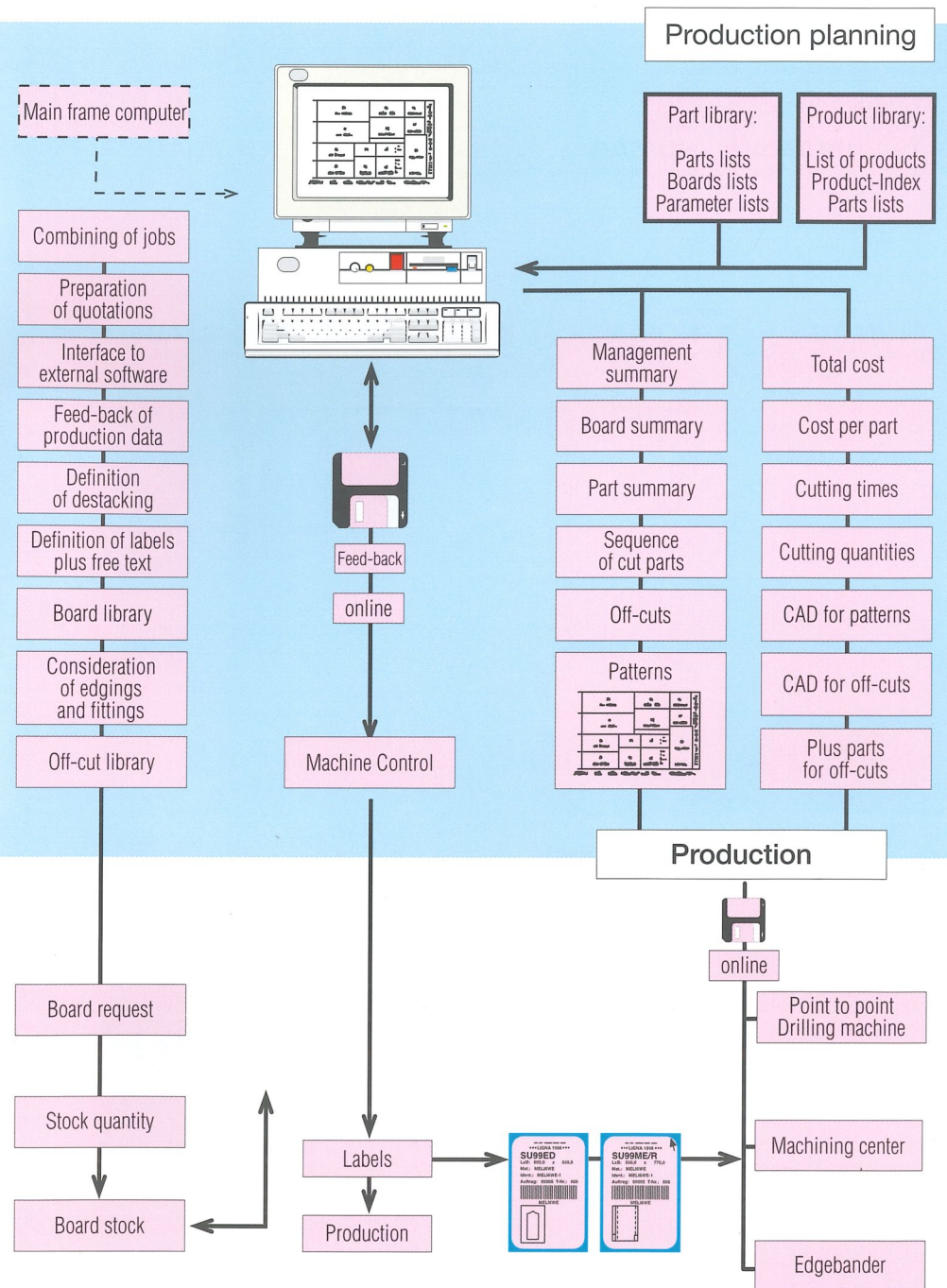

Umfassendes modulares HOLZMA-Softwarepaket für Ihren wirtschaftlichen Plattenzuschnitt.

Comprehensive, modulare HOLZMA software package for your economical cut-to-size operation.

Pack de logiciels HOLZMA modulaire, pour un débit économique de vos panneaux.

Paquete de modulos software para un corte de tableros rentable.

Pacchetto software HOLZMA, modulare e completo per una sezionatura economica dei pannelli.

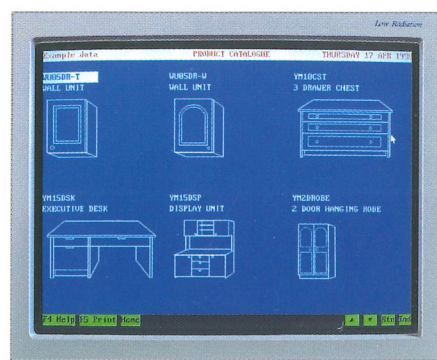
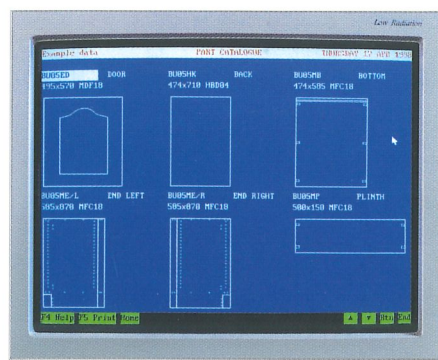

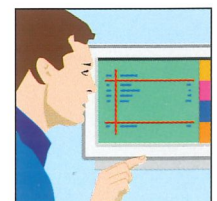
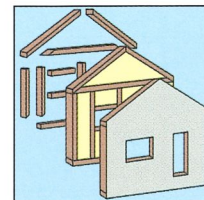
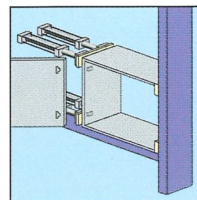
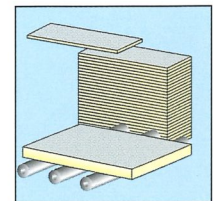
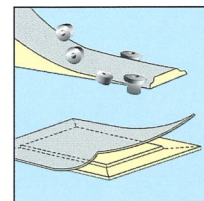
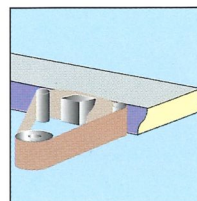
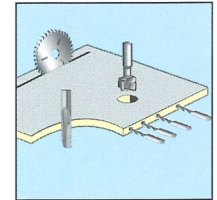
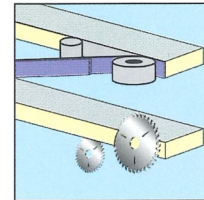
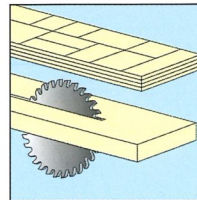

HOLZMA
Plattenaufteiltechnik GmbH
 Holzmastrasse 3
 D-75365 Calw-Holzbronn
 ☎ +49 (0) 70 53/69-0
 Fax +49 (0) 70 53/61 74
 info@holzma.de
 www.holzma.de



Niederlassung
 Dieselstrasse 73
 D-33442 Herzebrock-Clarholz
 ☎ +49 (0) 52 45/92 20 10
 Fax +49 (0) 52 45/92 20 44



HOLZMA=U.S., INC
 1200 Tulip Drive,
 Gastonia, NC 28052
 ☎ +1-704-861-8239
 Fax +1-704-867-4140
 holzmaus@stilesmachinery.com