

# WORLD

Numerically controlled  
machining centres

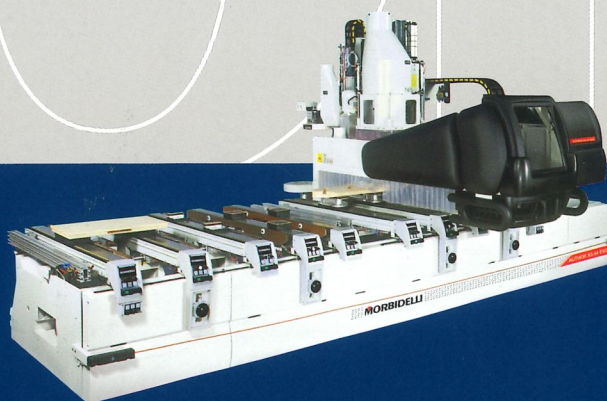

Author X5 · Author X5 Evo



**MORBIDELLI**

looking for these results...

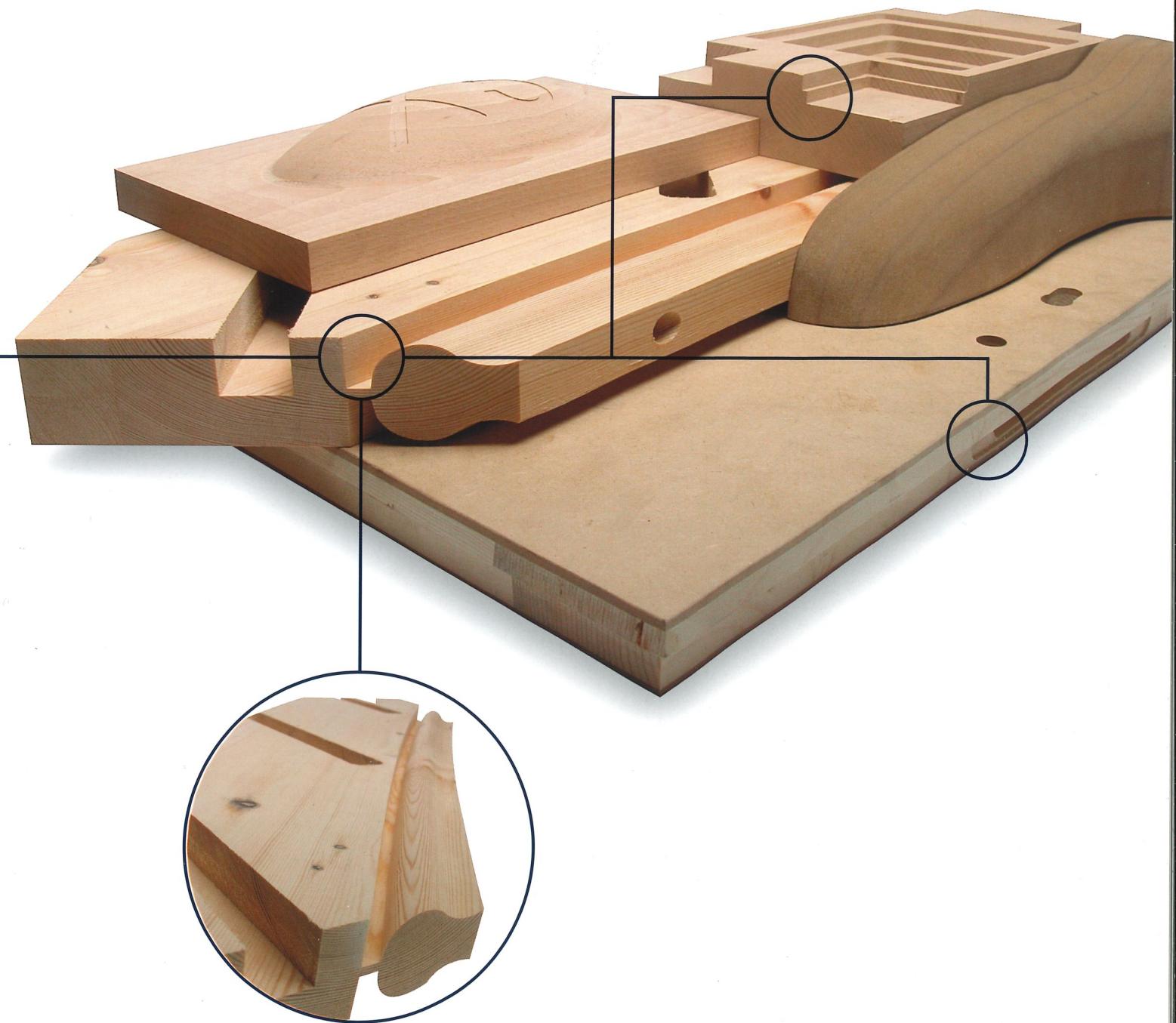

...this is the answer to change

- **Highly efficient production using the 5 controlled and interpolating axes.**
- **11 KW router units with HSK63 attachment, able to implement all operations**, which in the past could only be managed with a large number of units and additional aggregates.
- **Flexible machining** on all 6 faces of a work piece, with the possibility to change automatically up to **30** different tools.
- **All panel boring requirements satisfied** with the new heads that can support up to 30 vertical and 8 horizontal independent spindles.
- **A very large choice of worktables** to effectively satisfy all kind of needs.
- **No problems at all with a user-friendly operator interface and a PC office** with Windows operating system directly connected to a **dedicated numeric control**.

# Author X5

## Author X5 Evo

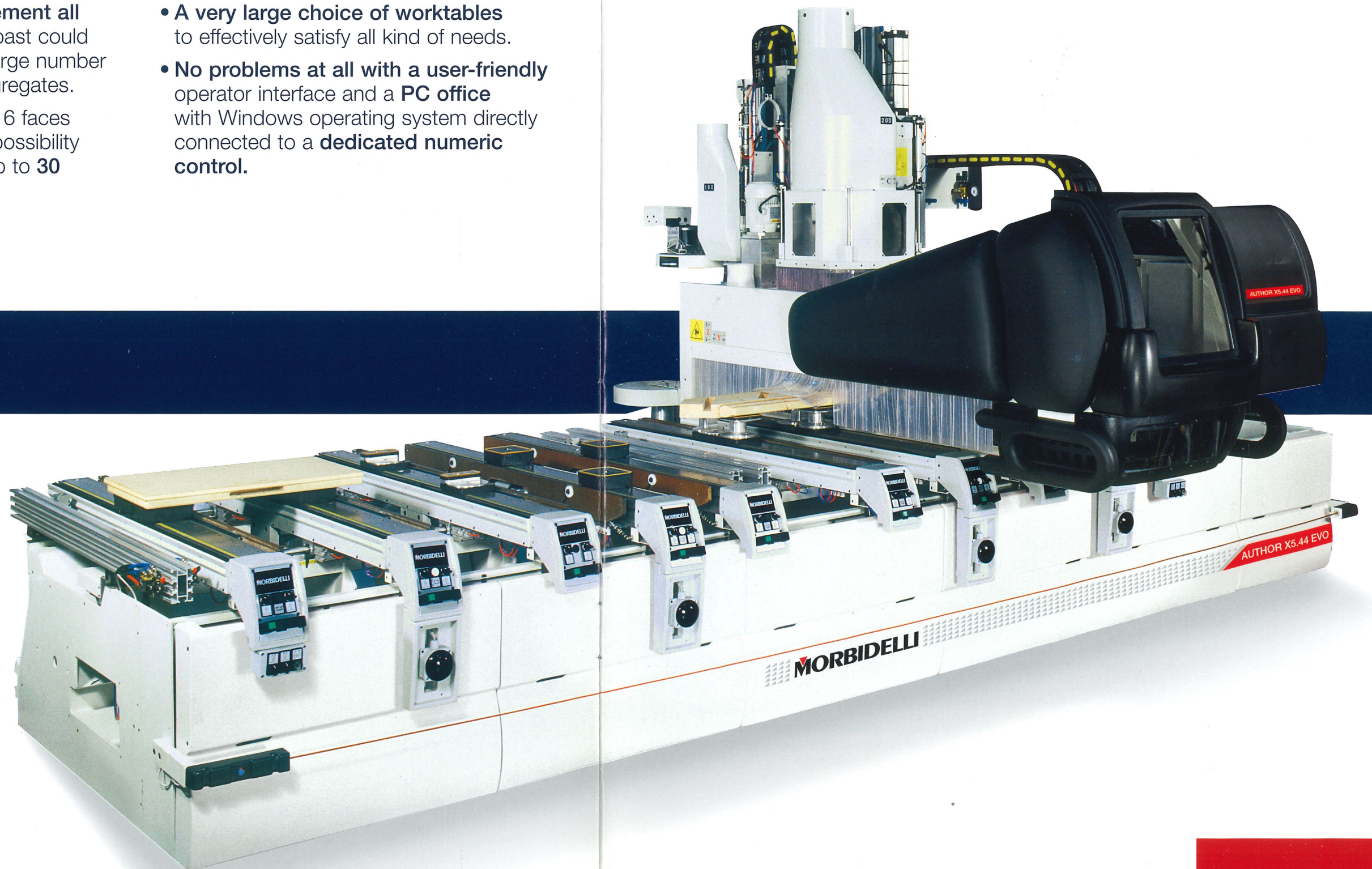

# If you want superior balance and strength.....

The structure is designed to guarantee maximum strength and to balance dynamic loads, giving high precision machining, both for boring and routing.

The self-supporting steel base with a triangular cross-section is a **solid and balanced support** for the machine's moving parts. The strengthening ribs and the large supporting base are designed and built to guarantee lasting machine stability and precision, under any working conditions.

The mobile machining unit consists of a **single-piece unit with one beam**. Its parts are electric arc-welded, for maximum torsional rigidity year after year.

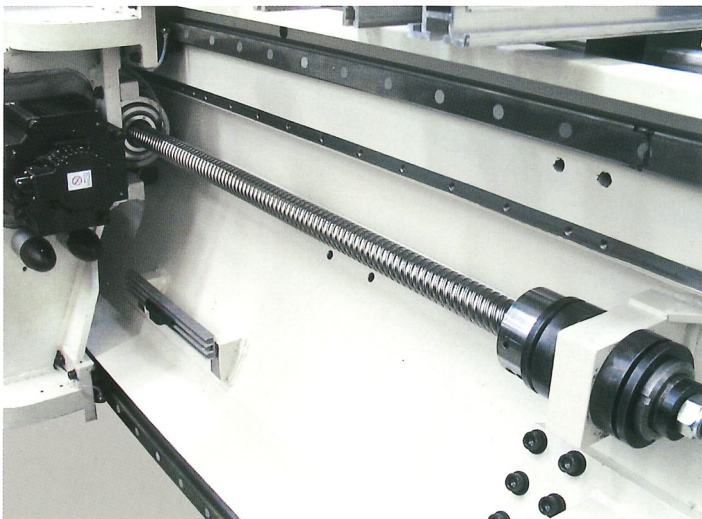
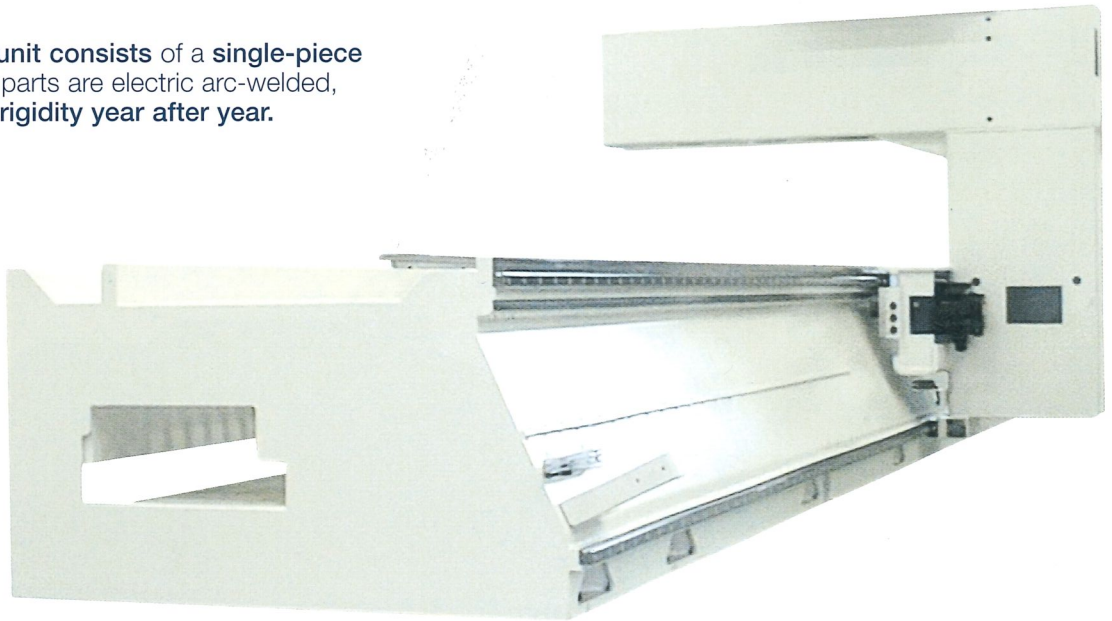

X, Y and Z axis movements are driven by Brushless motors on recirculating ball screws, allowing acceleration and **deceleration of up to 5 m/sec<sup>2</sup>** with absolute positioning precision. The axes movement does not require a particular maintenance, this because it can be lubricated automatically without any operator intervention.

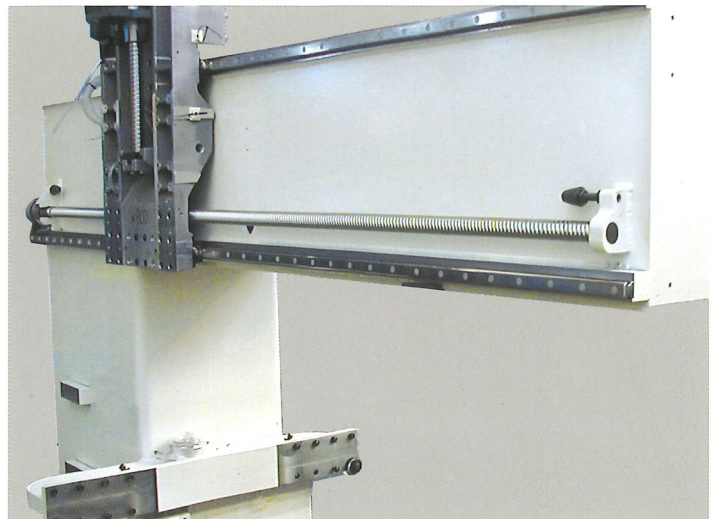

The mobile units run on **ground prism guides**, offset relative to their vertical axis to allow equal balancing of loads during machining.

# If you believe in an innovative and practical CE safety system.....

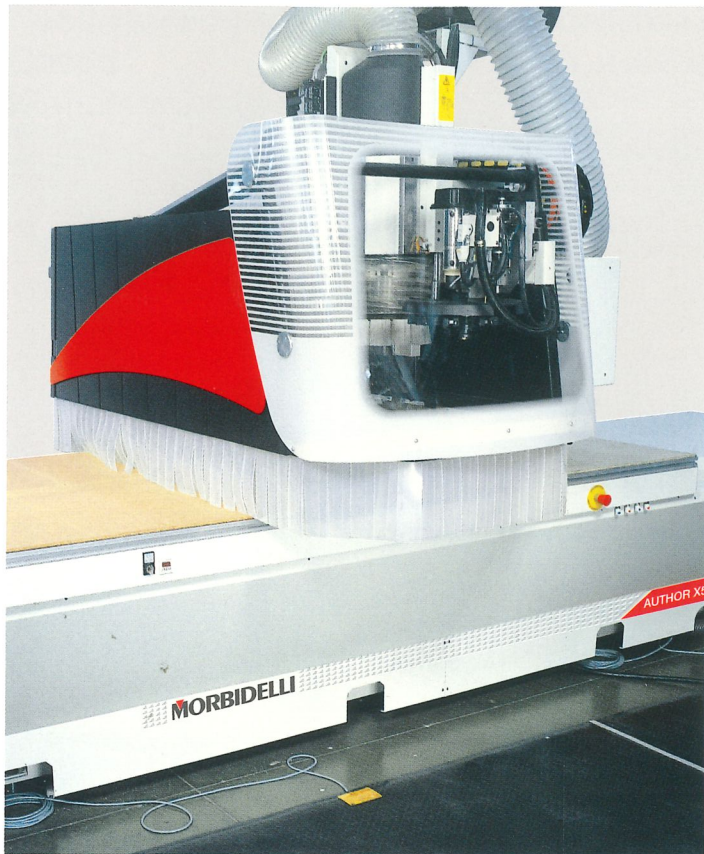

## Safety mats

This solution has three sensitive mats at the front of the machine. The mats are fitted with sensors, which stop the machining cycle when the operator enters the machine operating range. This so-called "active" safety system **prevents any contact** between the machine moving parts and the operator.

## Bumpers

This system has bumpers fitted around the mobile upright, with sensors which immediately stop the machine if there is any contact with obstacles.

**Operator safety is always safeguarded**, since any contact is dampened by the absorbent material used to make the bumpers and by the machine stopping immediately within just a few centimetres.

The advantages of this system are:

- **machine use at its maximum production capacity**, without unwanted interruptions in the production cycle;
- **possibility of pendulum machining on larger panels**, with the same X-axis machining range, compared with the solution with mats.



# If you're looking for fast and flexible worktable settings.....

All different panel hold-down requirements are satisfied with the worktable options in the Morbidelli range:



## Worktable with multi-function suction cups

These suction cups can operate both at the worktable level and 25 mm above it, in both cases allowing tilting along the Z-axis so as to hold down even panels that aren't completely flat. Passing from the lowered position to the raised position is fast and easy thanks to an ergonomically located device.



## Quick Set Up worktable

This type of table has aluminium supports without any tubes and pneumatic connections, which could obstruct suction cup positioning. The suction cups, of different sizes and heights, can be released from the individual supports and can be managed relative to the panel dimensions so as to concentrate the vacuum only where it's needed, increasing work piece hold-down efficiency.

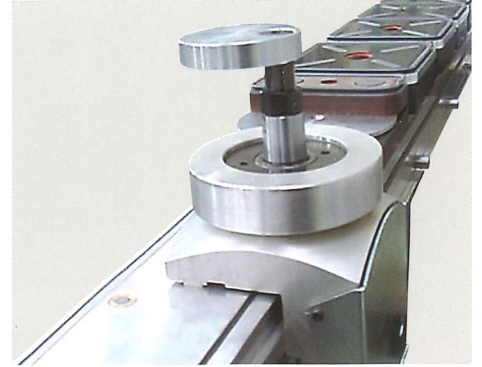

## Dedicated systems

Available with a high capacity compressed air system, for holding down special work pieces such as frames, uprights, etc.

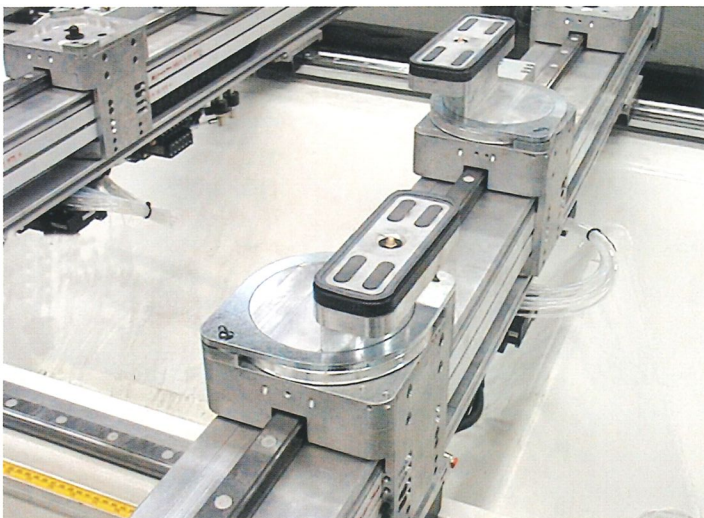

## FAT (Full Automatic Table)

A table with completely automated supports and suction cups which can move into position for the specific machining required within seconds.



## FET (Fast Electronic Table)

A solution which allows you to set up half a machine worktable while machining is being performed on the other side. Therefore, the times for this operation are masked by the machining cycle, which is never interrupted.

# Author X5 · Author X5 Evo

## Nesting Based Manufacturing

### Advantages

- Reduction of the rejected materials.
- Drastic lowering of the “Time to Market” due to the possibility to work on a single work order.
- Production of single pieces considerably shorter.
- Increase of quality of the finished product because of the less manipulation of pieces and thanks to the use of only a single machine.
- Reduction of the stock of work in progress parts; you produce only what it is sold.
- An almost completely automated solution and, so, with con reduction of labour use.
- Reduction of machinery which intervenes in the production run with consequent reduction of investments in equipment and of the impact of fixed costs.

The aluminium working table with vacuum locking allows a “nesting” processing and the production of all the pieces for a specific manufacture article (kitchen, wardrobe, desk or other) by optimising the use of one or more material papers as MDF, chipboard, multiplayer and so on.

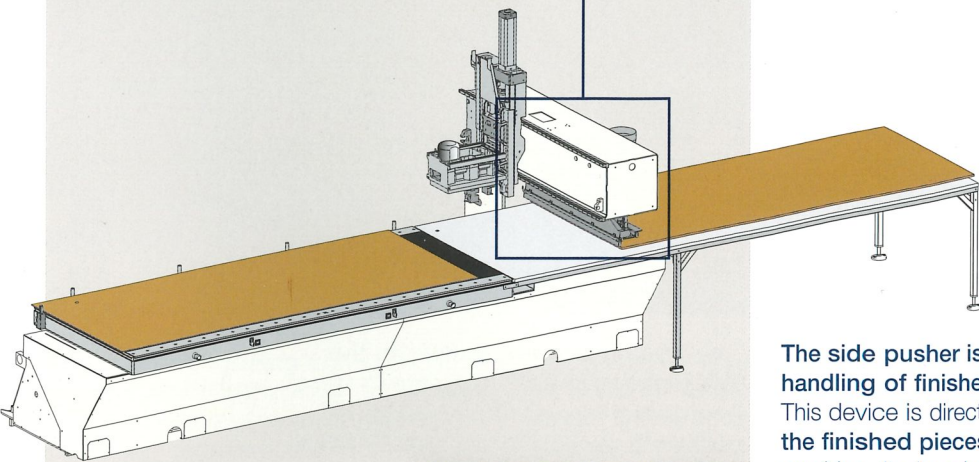
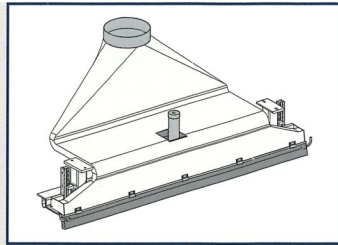

The side pusher is designed for an easy and automatic handling of finished pieces out of the machine. This device is directly mounted on mobile beam and it pushes the finished pieces on a support surface on the right end of the machine. It also cleans and clears the working area for next processing, thanks to a suction device. The operator can arrange the finished pieces without losing time, while the machine continues its working schedule.

# If you're looking for 360° flexibility...

X5 is a compact 5-axis routing unit with 11 kW of power. It is liquid cooled and has a boring head with 11/12 independent vertical spindles and, 4 horizontal spindles on the X-axis and 2/4 horizontal spindles on the Y-axis.

The main advantages of the universal routing unit are the possibility of machining at a minimum distance of 35 mm from the worktable (unique in its category) and always keeping the unit's centre of rotation at the tip of the tool used.

All of this gives a compact copy-router unit and exceptional performance in terms of power and working areas.

This flexibility exceeds the current configurations of conventional machining centres and opens up new possibilities for furniture manufacturers who need to rapidly adapt to meet customer requirements.

X5 further reduces machining times, compared with conventional solutions, and avoids unnecessary tool changes, there being no need to use dedicated units for special machining.

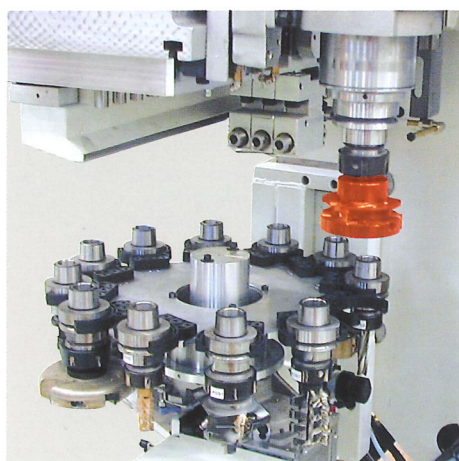

If you're using a very large number of tools, the Tool-Room with 12 tools, fitted directly on the mobile upright on the X-axis, always makes what you need available for machining with different profiles.

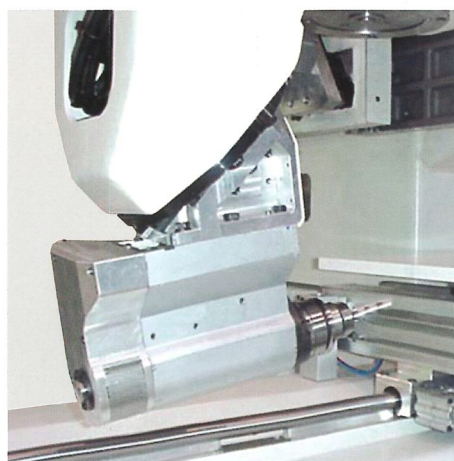

The X5 unit can rotate 640° in the X/Y plane and 270° in space to allow boring, cutting and routing up to 10° below the work piece orthogonal plane.



If you want  
always the best...

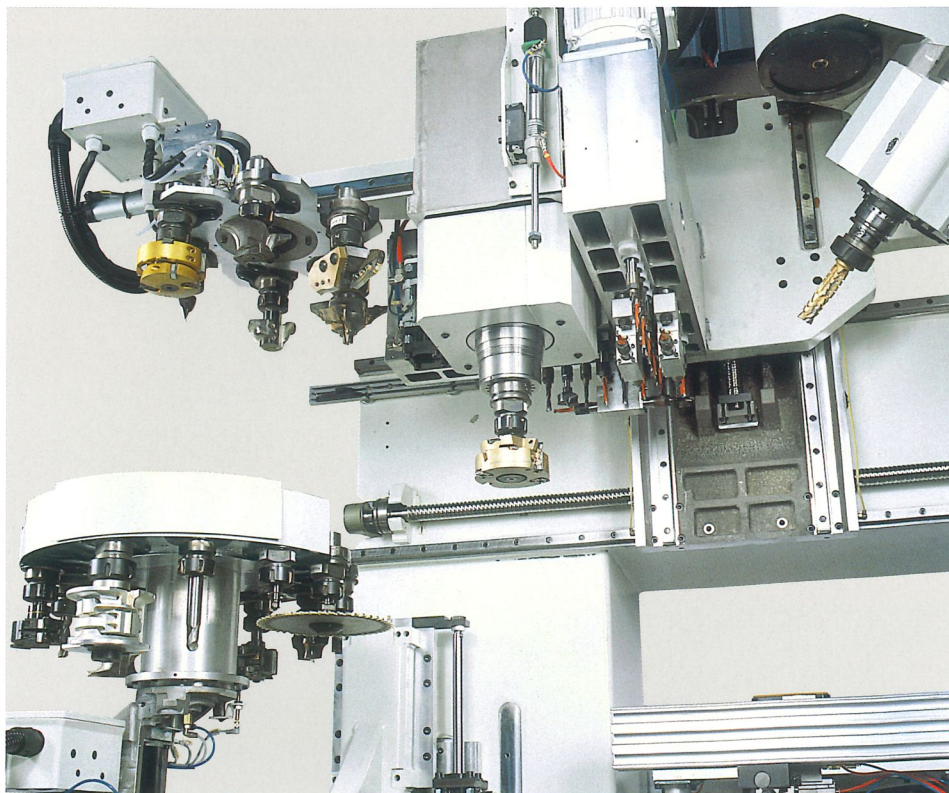

**X5 Evolution** is the natural development of a complete and reliable machine, that meets the requirements of those customers that, **moreover the 360° flexibility**, are looking for an higher number of tools on board of the machine both for drilling and routing. The Y axis 1780 mm working area is the ideal solution for each processing, from office furniture to the shop fitter.

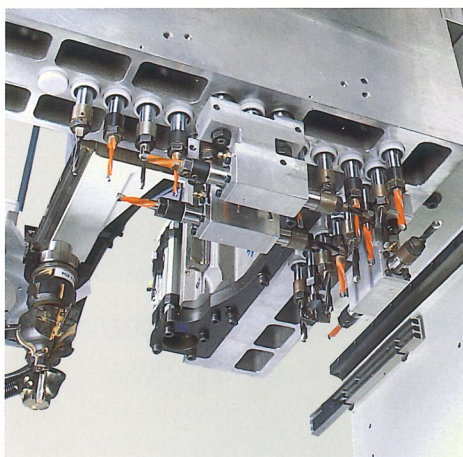

The powerful drilling unit with **18/30 vertical and 6 horizontal** independent spindles satisfies the most particular customers requirements. The complete set of bits is always available to allow the production process of always different pieces in the quickest time.

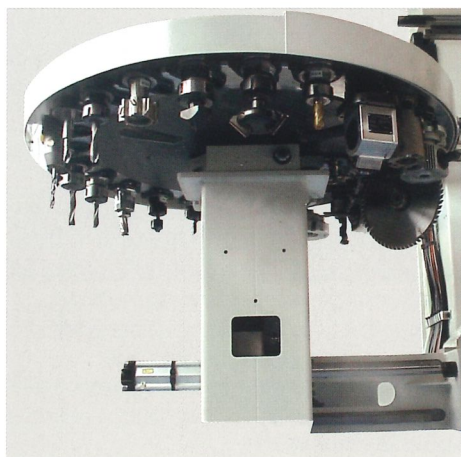

It's not necessary anymore to operate manually to replace the tool set on board of the machine between a production cycle and the following one, thanks to the new **24 positions Tool-Room** that satisfies all different requirements of routing process. Both the electro-spindles can automatically pick the tools up from the same magazine in order to **optimize and reduce the time of tool change**.

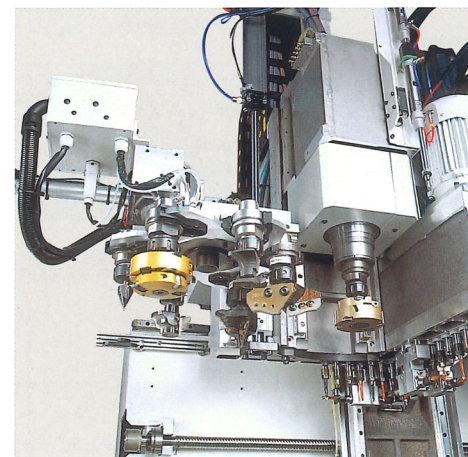

The advantage to have a **second routing unit of 7.5/11KW**, that can change tools in **masked time from a 6 positions RAPID tool crib**, while the main unit is operating, widely reduces machine down times and **it results in a shorter time of investment return**.

If you want a simple and immediately programmable numeric control...

Morbidelli machining centres are equipped with an innovative numeric control, with a Personal Computer as operator interface.



This solution guarantees the operator an **incomparable level of user friendliness and comfort, making work much easier.**

Morbidelli software operates in a **Windows environment for simple, effective programming.**

The software design takes into account programmer requirements, to cater for both expert operators and machining centre first time users.

**The graphical aids** allow intuitive programming, without extensive computer skills. Yet even those with more confidence will find something familiar in it, not requiring extra effort to take in new systems and will immediately be able to appreciate its great potential.



Remote control device to manage the main functions of the machine

### Main hardware features

- Intel processor (2.0 GHz or above);
- 15" colour monitor;
- Keyboard and mouse;
- 80 Gb (or above) hard disk;
- 3"1/2 floppy disk drive (1,44 Mb);
- CD ROM (48x);
- 256 Mb RAM memory (or above);
- 2 serial ports, 1 parallel port, 4 USB ports (to connect to any type of peripheral: bar code reader, modem, printer, scanner etc...);
- Network card (opt.), sound card.

# Author X5 · Author X5 Evo

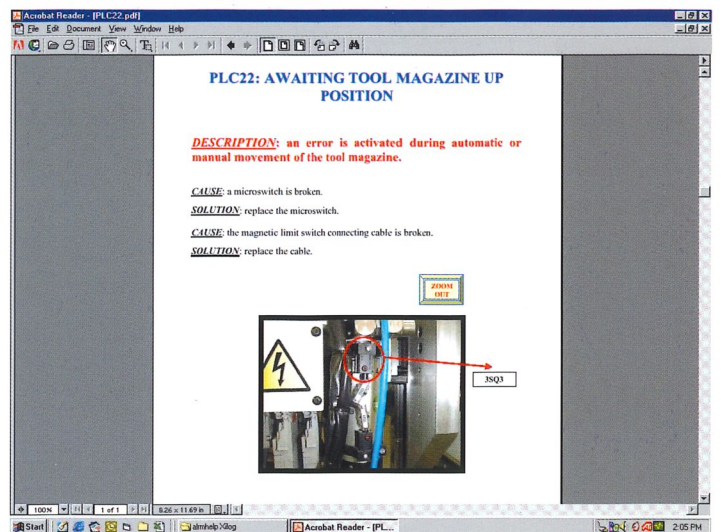
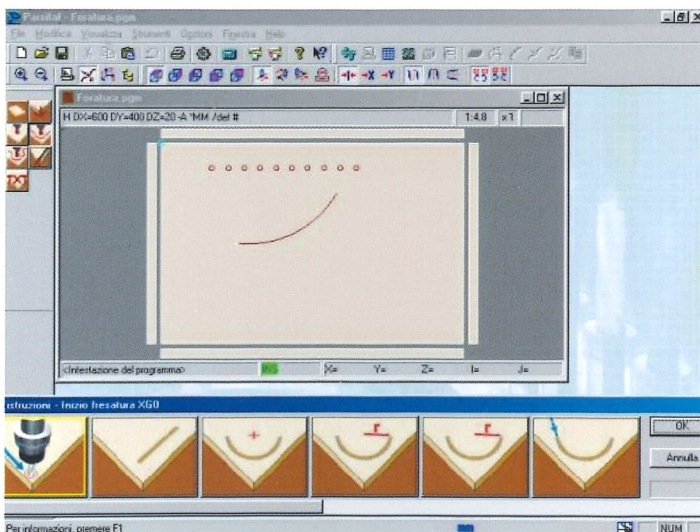
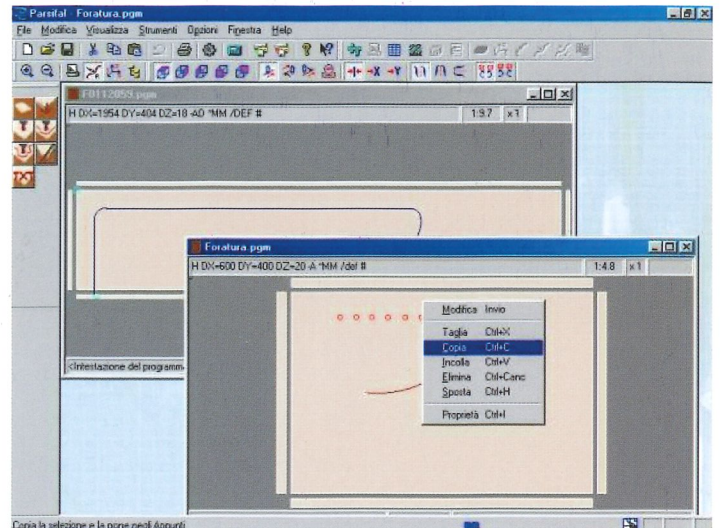
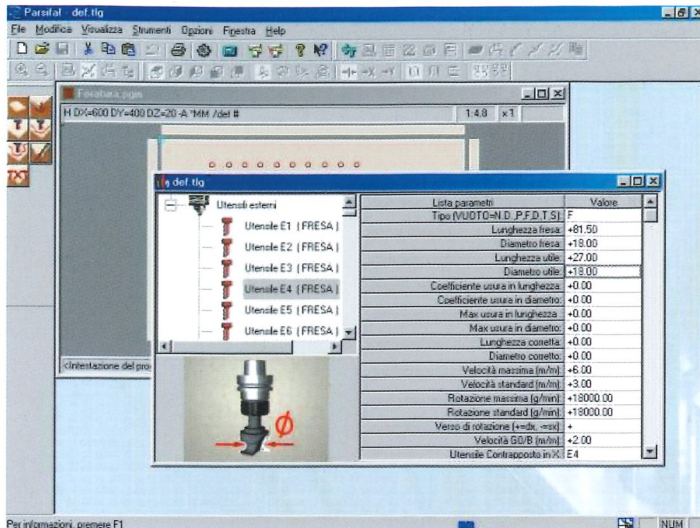

## Main software features

- Windows operating system with functions such as: copy, paste, edit, clear, properties, curtain menu, right click on the mouse for quick menu, multiple opening of windows etc.
- Equipping management with **tool visualisation** and with graphic supports to avoid the possibility of data input errors;
- **Immediate and direct uploads of DXF format files;**
- **Optimised dynamic drilling; graphic and syntactic aids** or drilling and milling operations to speed up data input operations;
- **Graphic visualisation of the manufactured piece** to allow for a quick and efficient check of the programme results;
- **Parametric programming**, to automatically update the programme when the sizes of the manufactured piece change, thus avoiding having to write a new programme;
- **Macro creation in a few minutes**, by using parametric programming;
- **Creation of programme blocks** that can be inserted inside other programmes;
- **Self diagnosis and warning of any errors** or possible failures through alarm messages in the user's language that aid quick understanding;
- **Graphic aids for the positioning of work supports** to avoid collisions with the tools in cases of passing drilling and/or milling to eliminate the empirical trials directly on the machine;
- Execution of programmes through bar codes.

# Working area

	Author X5-30	Author X5-32	Author X5-36	Author X5-44	Author X5-55	Author X5-67
X (mm)	3470	3870	4255	4940	6170	7380
X1 (mm)	3050	3200	3660	4400	5500	6700
X2 (mm)	1455	1530	1760	2130	2680	3280

Working area X5

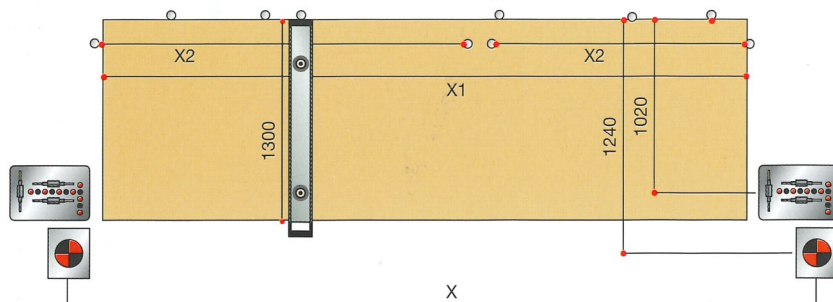

Working area X5 Evo

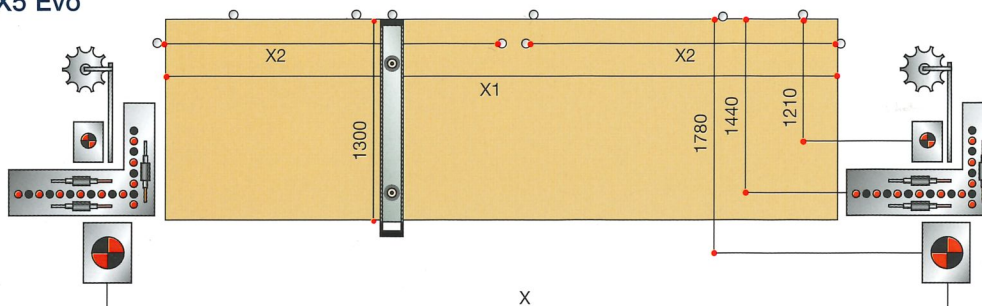

## Overall dimensions

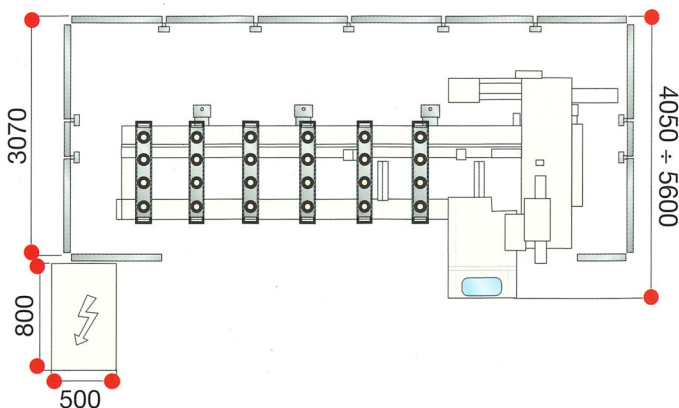
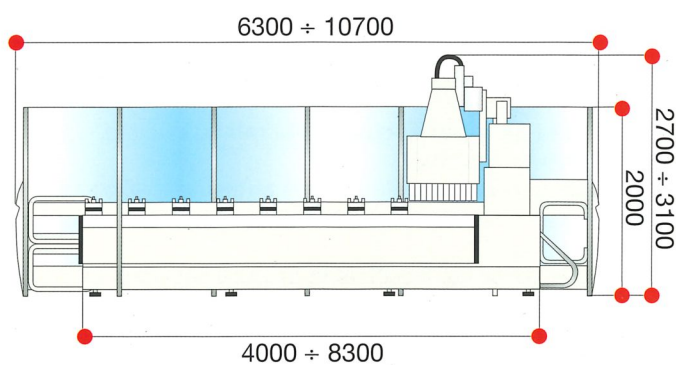

In this catalogue, machines are shown with options. The firm reserves the right to modify technical specifications without prior notice, provided that such modifications do not affect safety as per E.C. certification.

# Technical data

SINCERT



		X5	X5 Evo
Speed movement X axis	m/m	40/50/80	40/50/80
Speed movement Y axis	m/m	45/80	45/80
Speed movement Z axis	m/m	22,5	22,5
Electro-spindle power	KW	7,5/11,0	7,5/11,0
Max Diameter saw blade	mm	220	220
Speed drilling bits	rpm	4500/6000	4500/6000
N. vertical spindles		11/12	18/30
N. horizontal spindles		6/8	6
Tools available on tool-room		12	12/24
Tools available on rapid		-	6

		X5	X5 Evo
Work area in Y axis – drilling	mm	1020	1440
Work area in Y axis – routing	mm	1240	1780
Panel passage	mm	180	180
Y axis stroke	mm	1420	1920
Z axis stroke	mm	400	400
Intake air consumption	m³/h	5600	5600
Centralised extractor outlet diameter	mm	250/300	250/300
Installed power	KW	20 ÷ 30	20 ÷ 30
Weight	Kg	4000 ÷ 6000	4000 ÷ 6000

## Tools stroke Author X5

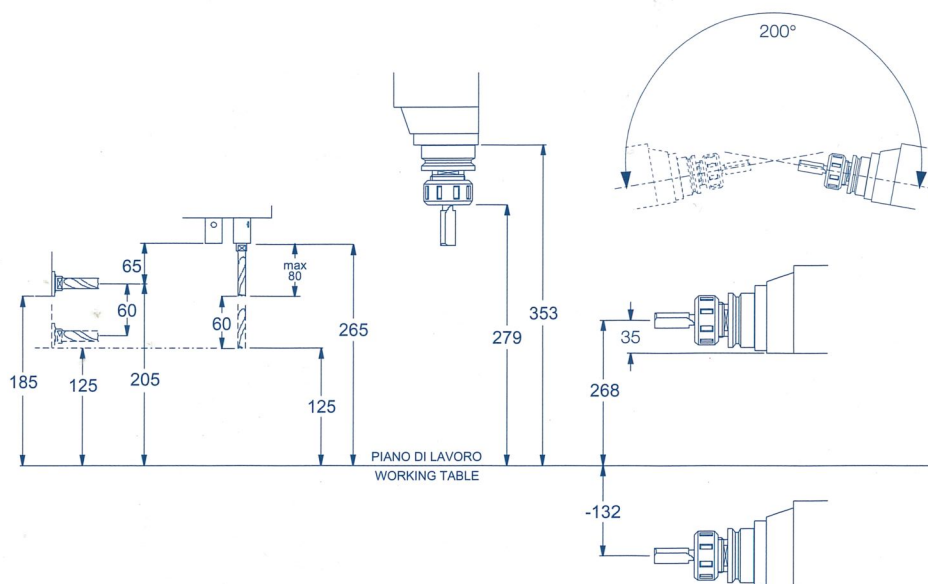

## Tools stroke Author X5 Evo

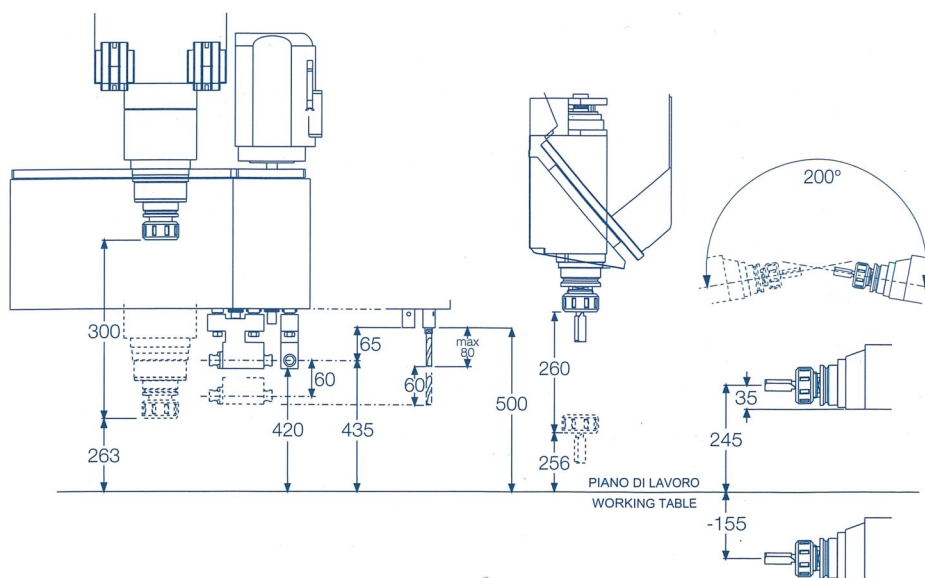

**MORBIDELLI**

MORBIDELLI

**MORBIDELLI**

SCM GROUP spa - MORBIDELLI - Strada Montefeltro, 81/3 - 61100 Pesaro - Italia  
Tel. +39/0721/4451 - Fax +39/0721/445264 - [www.scmgroup.com](http://www.scmgroup.com) - E-mail: [morbidelli@scmgroup.com](mailto:morbidelli@scmgroup.com)