



e scm

**La più vasta gamma di macchine
per la lavorazione del legno**

**The widest range
of woodworking machines**

**Die größte Palette
von Holzbearbeitungsmaschinen**

**La gamme la plus complète
de machines à bois**

**La gama más completa de máquinas
para el trabajo de la madera**

La più vasta gamma di macchine
per la lavorazione del legno
per piccole, medie e grandi industrie

The widest range of woodworking machines
for small, medium and large industries

Die größte Palette
von Holzbearbeitungsmaschinen
für Klein-, Mittel- und Großbetriebe

La gamme la plus complète de machines
à bois pour les petites, moyennes
et grandes entreprises

La gama más completa de maquinas
para el trabajo de la madera.
Para pequeñas, medianas y grandes empresas.

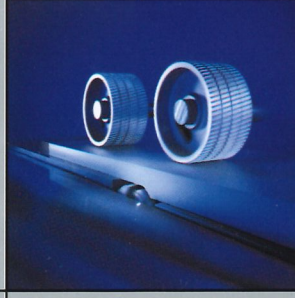
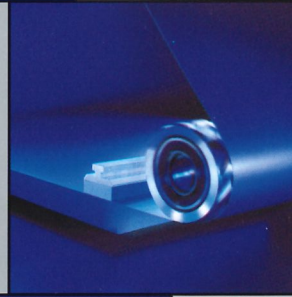
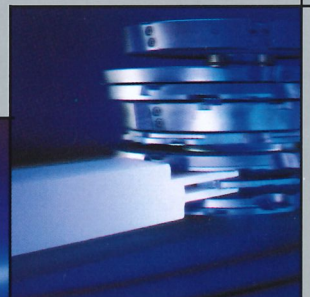
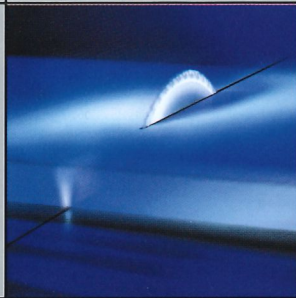
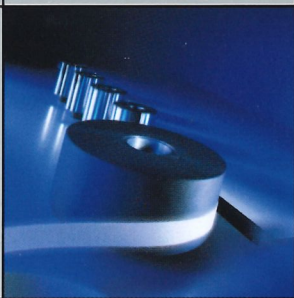
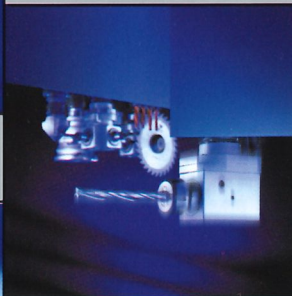
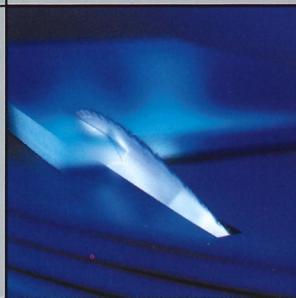

4	Centri di lavoro e di fresatura a CNC	CNC machining and routing centres	CNC- Fräs- und Bearbeitungszentren	Centres d'usinage et de fraisage à CN	Centros de trabajo y de fresado a CNC
8	Scorniatrici piallatrici automatiche	Automatic profiling multiplaners and throughfeed moulders	Vierseitenhobel-, Kehl- und Profilfräsautomaten	Corroyeuses moulurières automatiques	Cepilladoras moldureras automáticas
10	Linee integrate e centri di lavoro a CNC per serramenti	CNC window processing lines and machining centres	CNC- Fensterfertigungsanlagen und Bearbeitungszentren	Lignes intégrées et centres d'usinage à CN pour menuiseries	Sistemas integrados y centros de trabajo a CNC para ventanas
12	Squadratrici-tenonatrici automatiche	Automatic tenoners	Profil- und Zapfenschneidautomaten	Tenonneuses automatiques	Escuadradoras espigadoras automáticas
14	Macchine classiche per la falegnameria artigiana	Classical machines for individual woodworkers	Standardmaschinen für Handwerksbetriebe	Machines classiques pour les entreprises artisanales	Máquinas clásicas para empresas artesanas
20	Centri di sezionatura	Panel sizing centres	Plattenaufteilanlagen	Centres pour sciage de panneaux	Centros de corte para tableros
22	Bordatrici monolaterali automatiche	Automatic single sided edge banders	Einseitige Kantenleimautomaten	Plaqueuses de chants automatiques monolatérales	Chapadoras automáticas monolaterales
24	Centri di fora-fresatura a CNC e foratrici semiautomatiche	CNC boring and routing centres and semi-automatic boring machines	CNC- Bohr- und Fräszentren und halbautomatische Bohrautomaten	Centres de perçage et de fraisage à CN et perceuses semi-automatiques	Centros de taladro y fresado a CNC y taladros semi-automáticos
26	Calibratrici levigatrici automatiche	Automatic calibrating and sanding machines	Kalibrier- und Feinschleifautomaten	Calibreuses ponceuses automatiques	Lijadoras calibradoras automáticas

Centri di lavoro e di fresatura a CNC

CNC machining and routing centres

CNC- Fräs- und Bearbeitungszentren

Centres d'usinage et de fraisage à CN

Centros de trabajo y de fresado a CNC

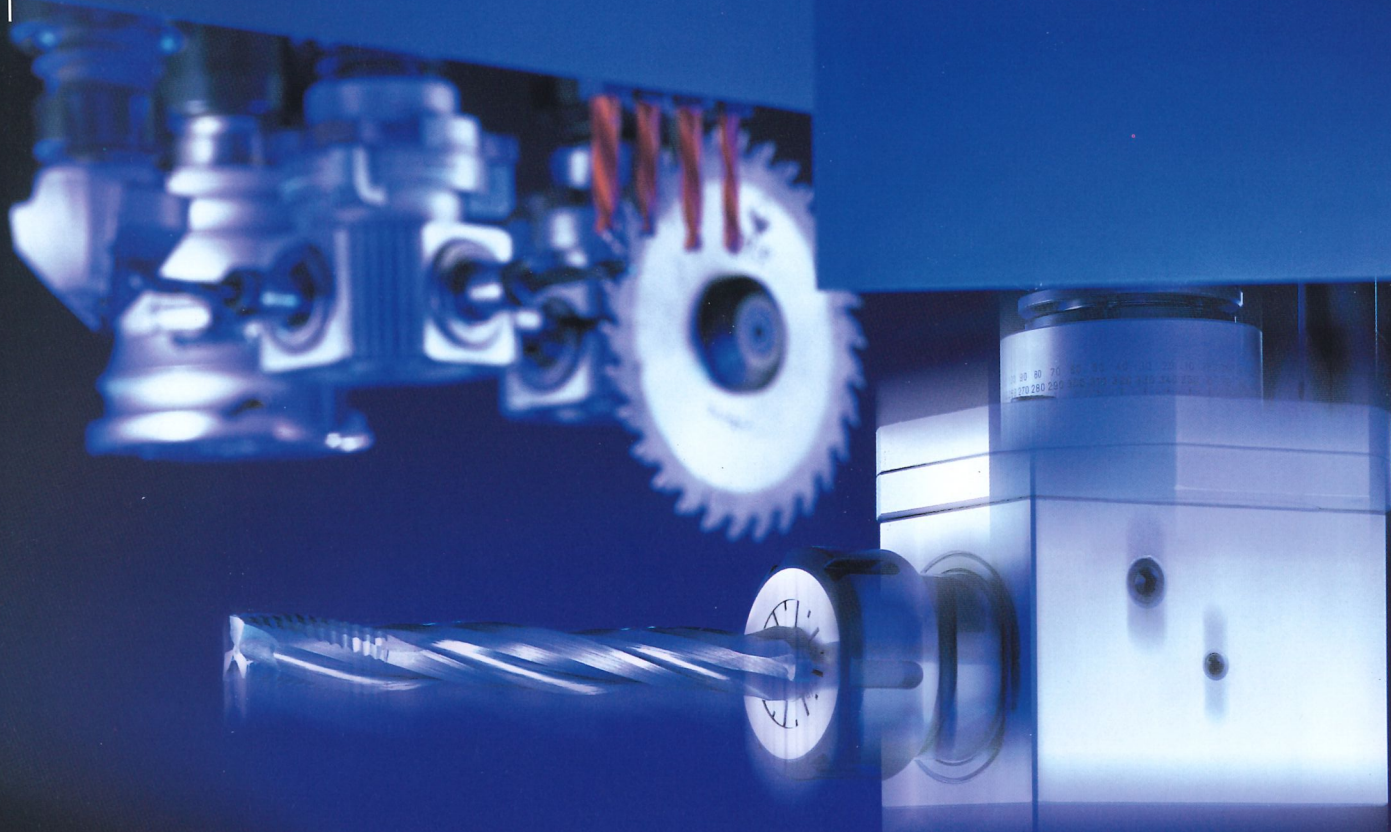

Ergon

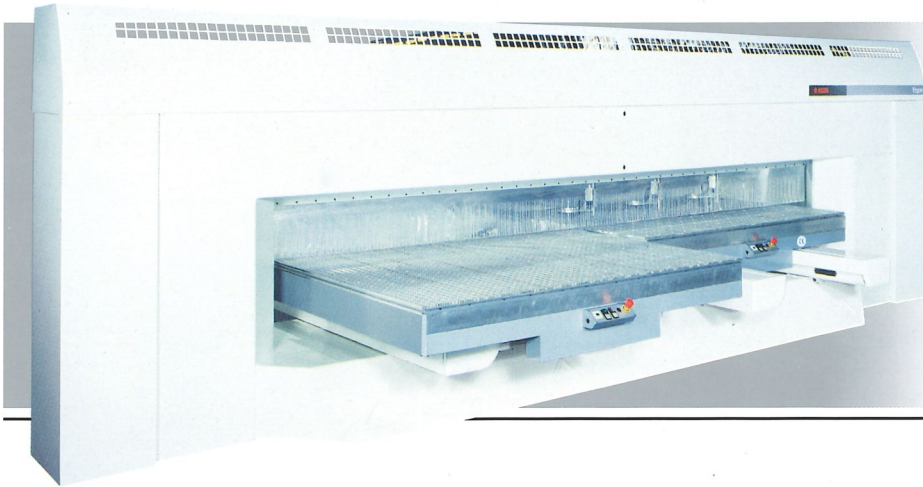

Centro di fresatura
di elevata produttività

Routing centre
for high productivity

Fräszentrum
für Höchstleistung

Centre de fraisage
pour grande productivité

Centro de fresado
para una gran productividad

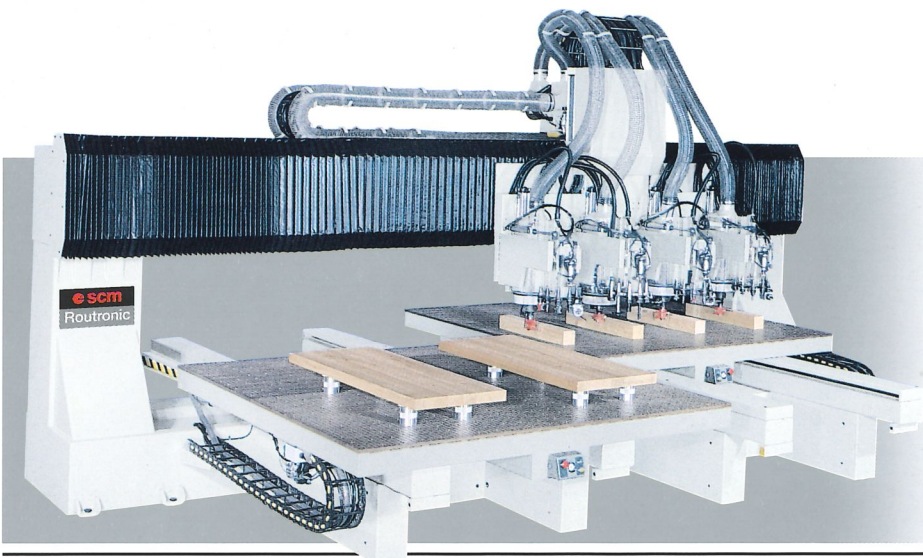

Routronic PCU

Centro di fresatura a composizione
modulare per alta produttività

Routing centre with modular
composition for high productivity

Fräszentrum mit modularer
Konfiguration für Höchstleistung

Centre de fraisage à composition
modulaire pour grande productivité

Centro de fresado con composición
modular para una gran productividad

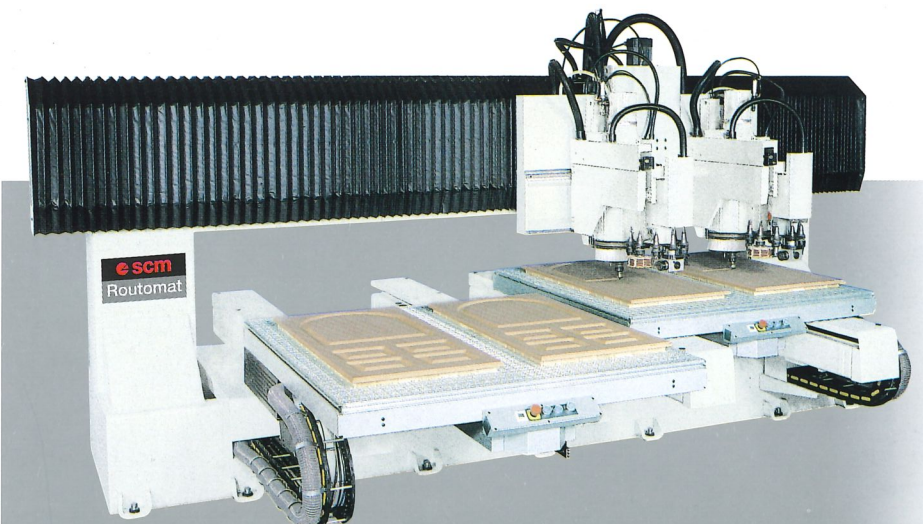

Routomat PCU

Centro di fresatura a composizione
modulare per alta produttività

Routing centre with modular
composition for high productivity

Fräszentrum mit modularer
Konfiguration für Höchstleistung

Centre de fraisage à composition
modulaire pour grande productivité

Centro de fresado con composición
modular para una gran productividad

Record 240

Centro di lavoro a composizione
modulare per impieghi industriali

Working centre with modular
composition for industrial use

Bearbeitungszentrum mit modularer
Konfiguration für industriellen Einsatz

Centre d'usinage à composition
modulaire pour l'industrie

Centro de trabajo con composición
modular para uso industrial

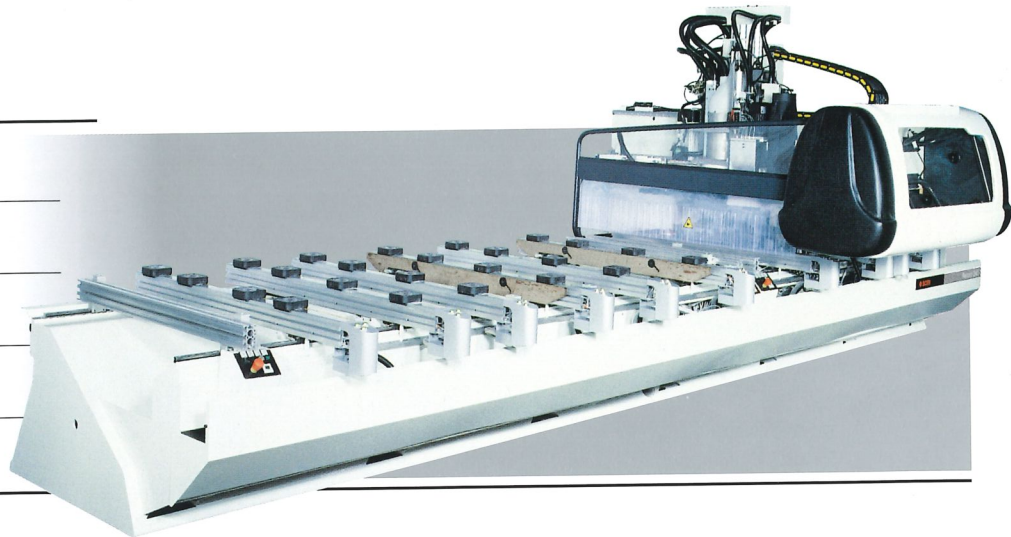

Record 220 TVS

Centro di lavoro con piano a ventose
per universalità d'impiego

Machining centre with suction cup
worktable for universal use

Bearbeitungszentrum mit einem Arbeitstisch
mit Vakuumsauger für den Universaleinsatz

Centre d'usinage avec table à
ventouses pour universalité d'emploi

Centro de trabajo con mesa
de ventosas para uso universal

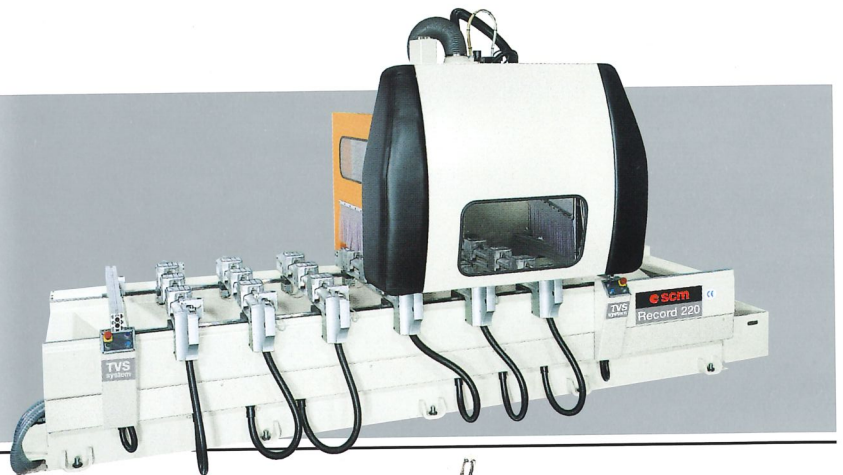

Record 220 NWT

Centro di lavoro
per serramenti

Door and window
frame working centre

Türen- und
Fensterbearbeitungszentrum

Centre d'usinage pour la production
de portes et de fenêtres

Centro de trabajo
para puertas y ventanas

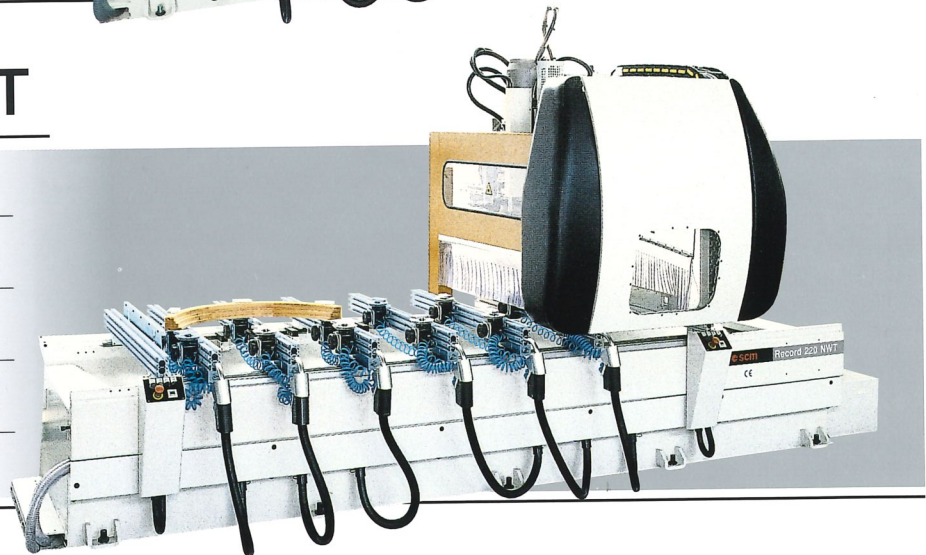

Record 220

Centro di lavoro con piano
multifunzionale di elevata flessibilità

Machining centre with multipurpose
worktable for high flexibility

Bearbeitungszentrum mit multifunktionellem
Arbeitstisch für hohe Flexibilität

Centre d'usinage avec table multi-
fonctions pour grande flexibilité

Centro de trabajo con mesa
multifuncional para gran flexibilidad

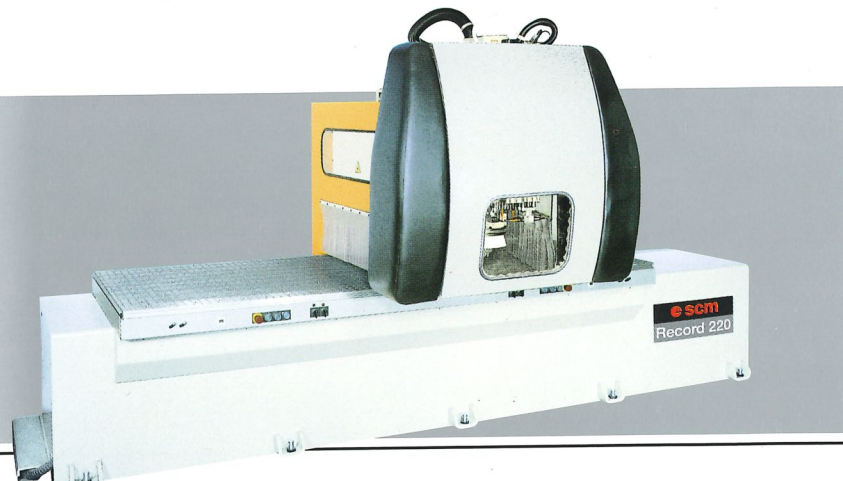



Record 130

Centro di lavoro universale
per piccole e medie industrie

Universal working centre for small
and medium sized companies

Universelles Bearbeitungszentrum
für Klein- und Mittelbetriebe

Centre d'usinage universel
pour petites et moyennes industries

Centro de trabajo universal
para pequeñas y medianas empresas

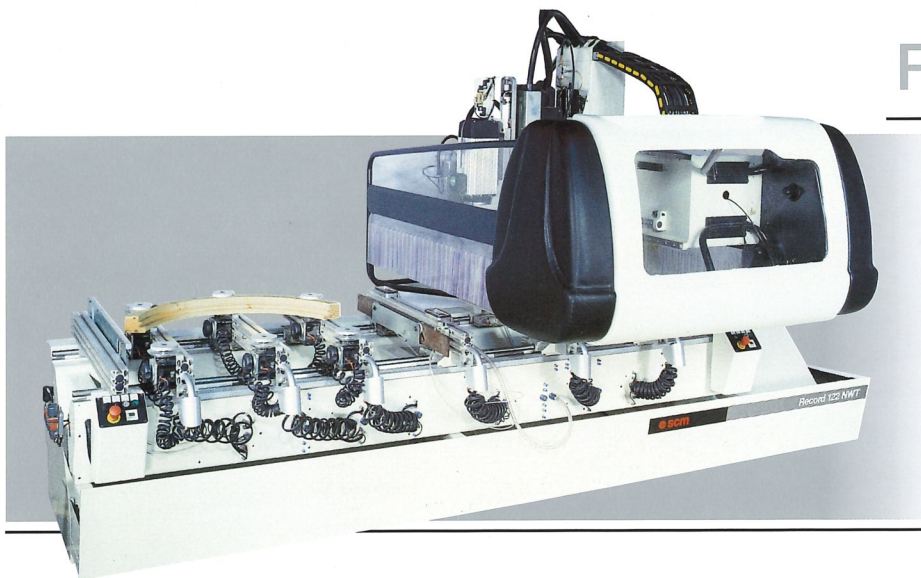

Record 122 NWT

Centro di lavoro
per serramenti

Door and window frame
working centre

Türen- und
Fensterbearbeitungszentrum

Centre d'usinage pour la production
de portes et de fenêtres

Centro de trabajo
para puertas y ventanas

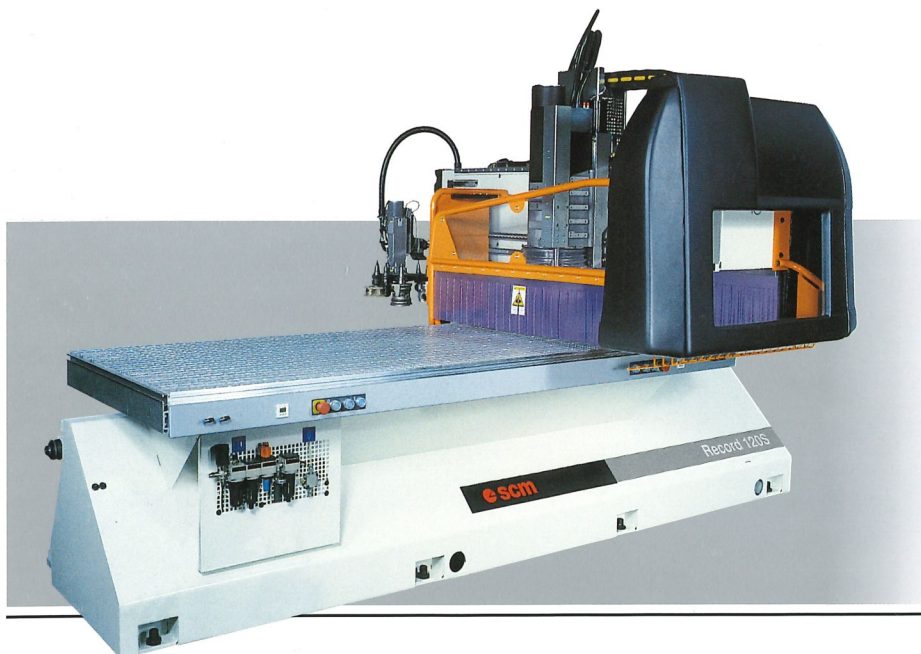

Record 120S

Centro di lavoro flessibile
per uso artigianale

Flexible working centre
for small woodworking companies

Vielseitiges Bearbeitungszentrum
für Handwerksbetriebe

Centre d'usinage flexible
pour entreprises artisanales

Centro de trabajo flexible
para empresas artesanas

Scorniatrici piallatrici automatiche

Automatic profiling multiplaners and throughfeed moulders

Vierseitenhobel-, Kehl- und Profilfräsautomaten

Corroyeuses moulurières automatiques

Cepilladoras moldureras automáticas

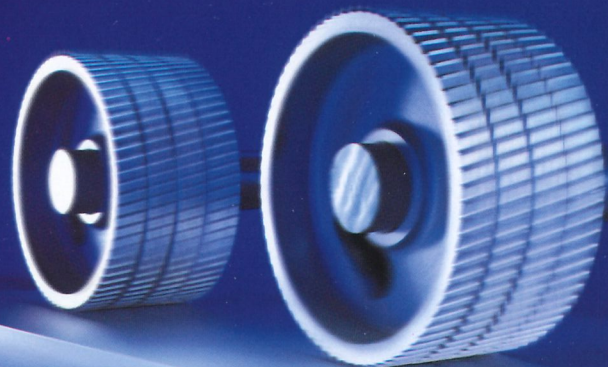

Topset 23

Scorniatrica automatica per uso industriale ed intensivo ad alta flessibilità

Automatic throughfeed moulder for industrial and heavy duty use with high flexibility

Profilfräsautomat für industriellen und intensiven Einsatz mit hoher Flexibilität

Moulurière automatique pour l'industrie à usage intensif, à grande flexibilité

Moldurera automática para uso industrial intensivo de gran flexibilidad



Superset 23 plus

Scorniatrica automatica per uso industriale ad alta flessibilità

Automatic throughfeed moulder for industrial use with high flexibility

Profilfräsautomat für industriellen Einsatz mit hoher Flexibilität

Moulurière automatique pour l'industrie, à grande flexibilité

Moldurera automática para uso industrial de gran flexibilidad

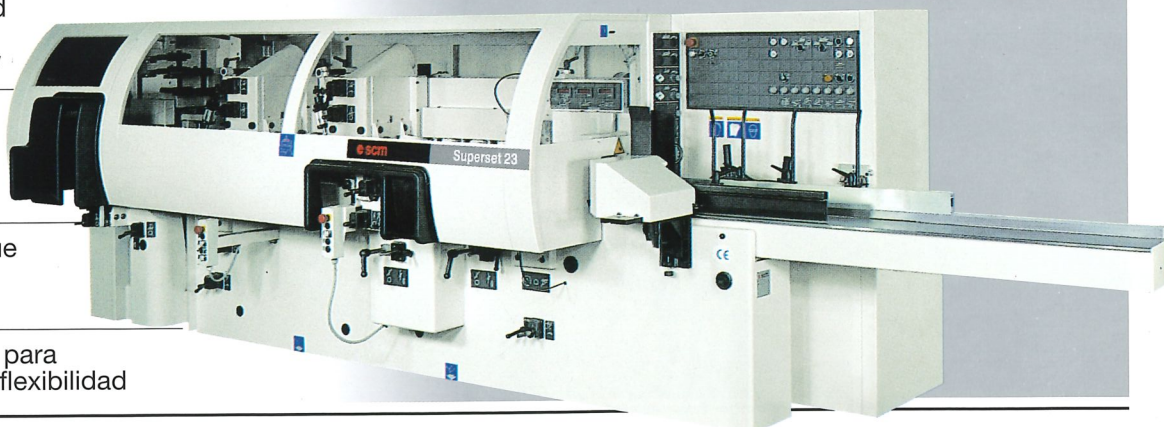

Superset XL



Scorniatrica automatica
per uso industriale

Automatic throughfeed
moulder for industrial use

Profilfräsautomat für
industriellen Einsatz

Moulière automatique
pour l'industrie

Moldurera automática
para uso industrial

Compact 23 K/K super



Piallatrice scorniatrica automatica
per uso artigianale

Automatic throughfeed planer
moulder for individual woodworkers

Vierseitenhobel- und
Kehlautomaten für
Handwerksbetriebe

Corroyeuse moulière
automatique pour
entreprises artisanales

Cepilladora-moldurera automática
para empresas artesanas

Sintex XL

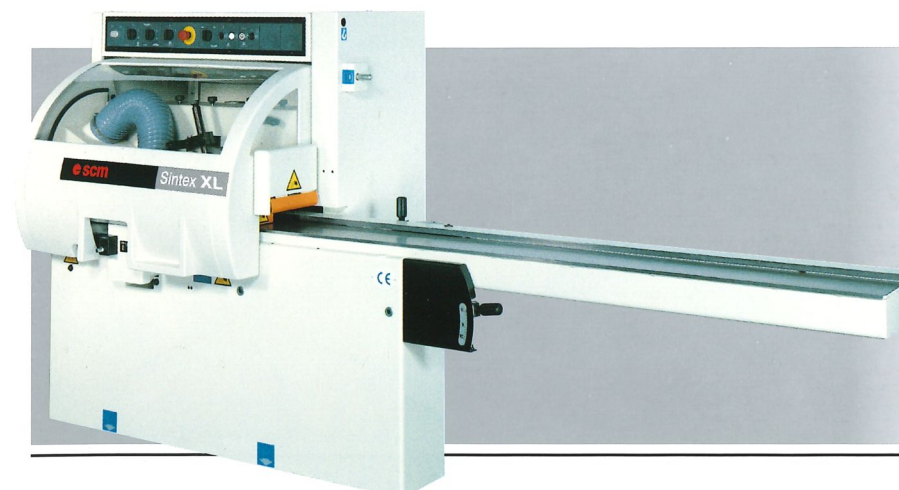

Piallatrice profilatrice automatica
per uso artigianale

Automatic profiling multiplaner
for small woodworking companies

Vierseitenhobel- und Profilierautomat
für Handwerksbetriebe

Corroyeuse profileuse automatique
pour entreprises artisanales

Cepilladora-perfiladora automática
para empresas artesanas

Linee integrate e centri di lavoro a CNC per serramenti

CNC window processing lines and machining centres

CNC- Fensterfertigungsanlagen und Bearbeitungszentren

Lignes intégrées et centres d'usinage à CN pour menuiseries

Sistemas integrados y centros de trabajo a CNC para ventanas



System 5 S

Linea integrata per produzione serramenti ad alta flessibilità e capacità produttiva

Integrated windows processing line with high flexibility and high production capacity

Integrierte Fensterfertigungsanlage mit hohe Flexibilität und große Produktionskapazitäten

Ligne intégrée pour menuiseries à grande flexibilité et grande capacité de production

Sistema integrado para ventanas de gran flexibilidad y capacidad productiva

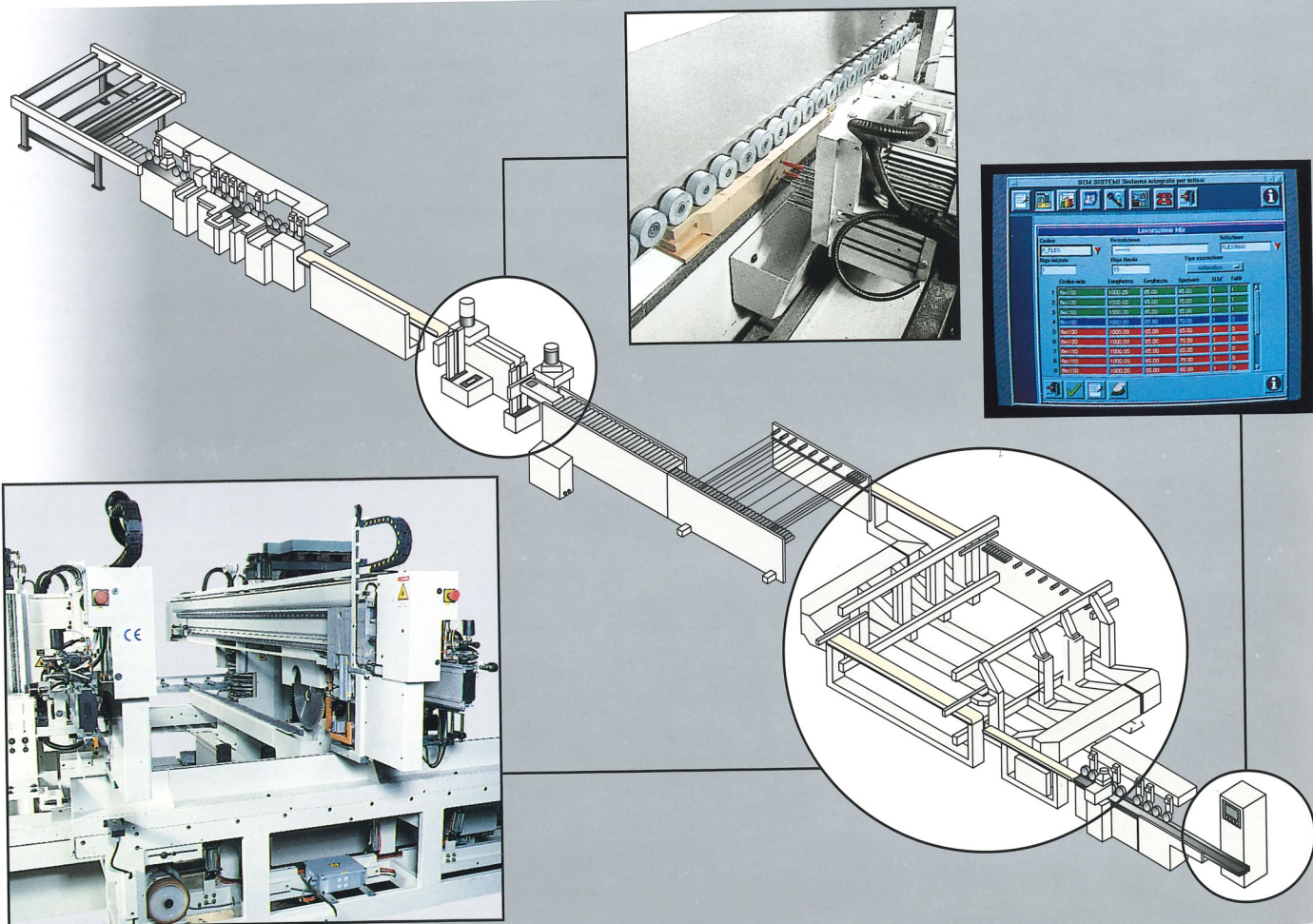

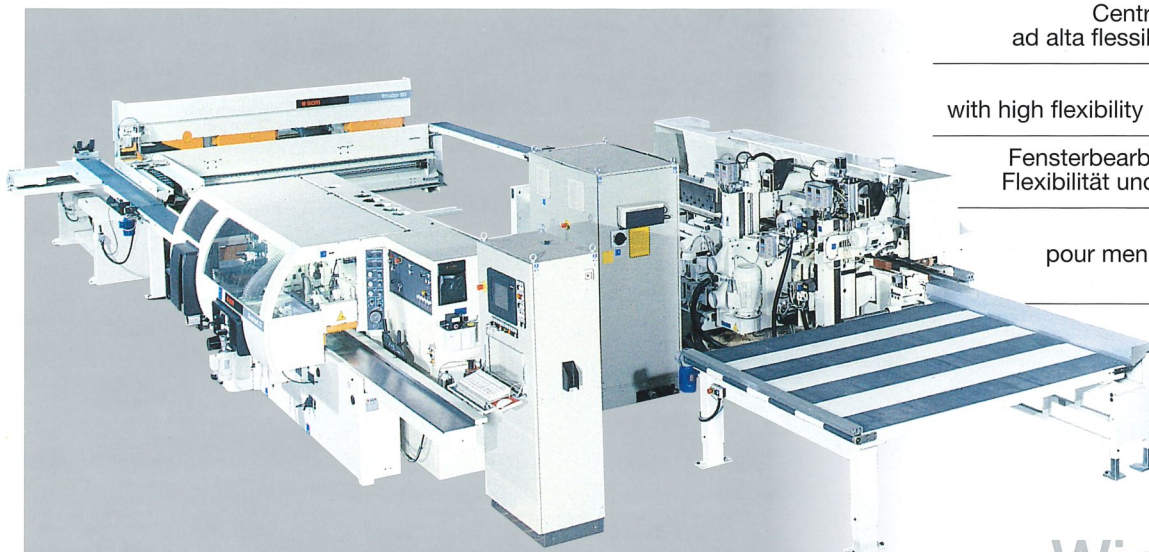

Centri di lavoro per serramenti
ad alta flessibilità e media produttività

Window working centres
with high flexibility and medium productivity

Fensterbearbeitungszentren mit hoher
Flexibilität und maximaler Produktivität

Centres d'usinage
pour menuiseries à haute flexibilité
et productivité moyenne

Centros de trabajo
para ventanas
de gran flexibilidad
y media productividad

Windor 60/S

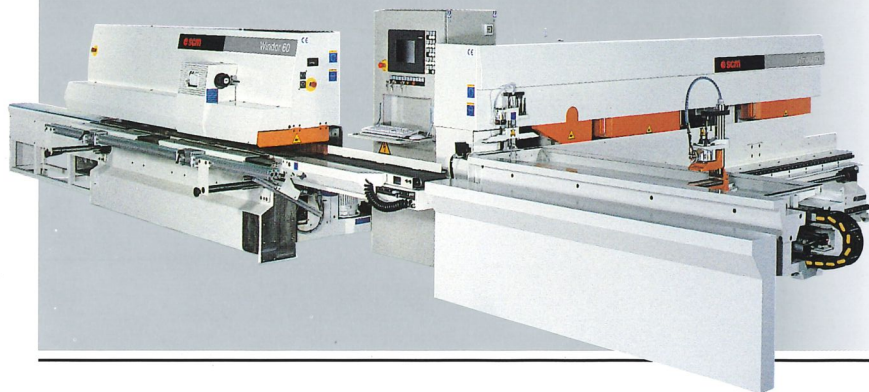

Windor 60

Method K super

Centro di lavoro per serramenti
ad uso artigianale

Window working centre
for small woodworking companies

Fensterbearbeitungszentrum
für Handwerksbetriebe

Centre d'usinage
pour menuiseries pour artisans

Centro de trabajo para ventanas
para uso artesanal



Kontur

Sbattentatrici monolaterali
automatiche per uso industriale

Automatic single-sided profiling
shapers for industrial use

Einseitige Umfälzautomaten
für industriellen Einsatz

Calibreuses automatiques
monolaterales pour l'industrie

Perfiladoras de contornos monolaterales
automáticas para uso industrial

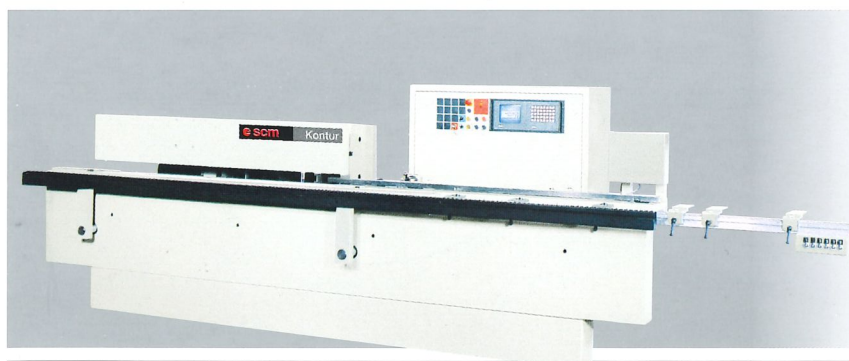

Squadratrici-tenonatrici automatiche

Automatic tenoners

Profil- und Zapfenschneidautomaten

Tenonneuses automatiques

Escuadradoras espigadoras automáticas

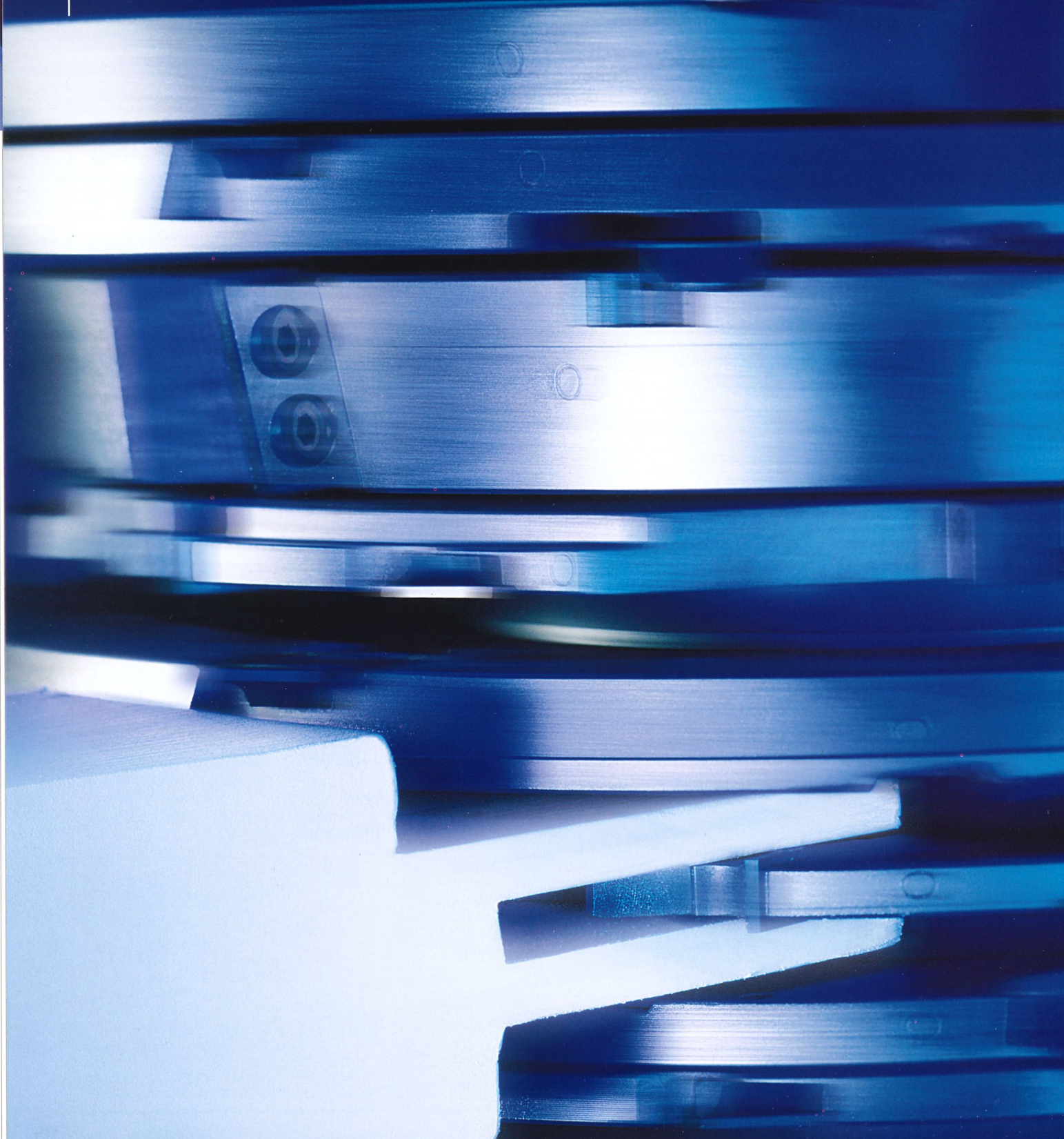

Concept 2000

Squadratrice doppia automatica a composizione modulare

Automatic double end tenoner with modular composition

Doppelendprofil- und Zapfenschneidautomat mit modularer Konfiguration

Tenonneuse double automatique à composition modulaire

Esquadradora espigadora doble automática con composición modular

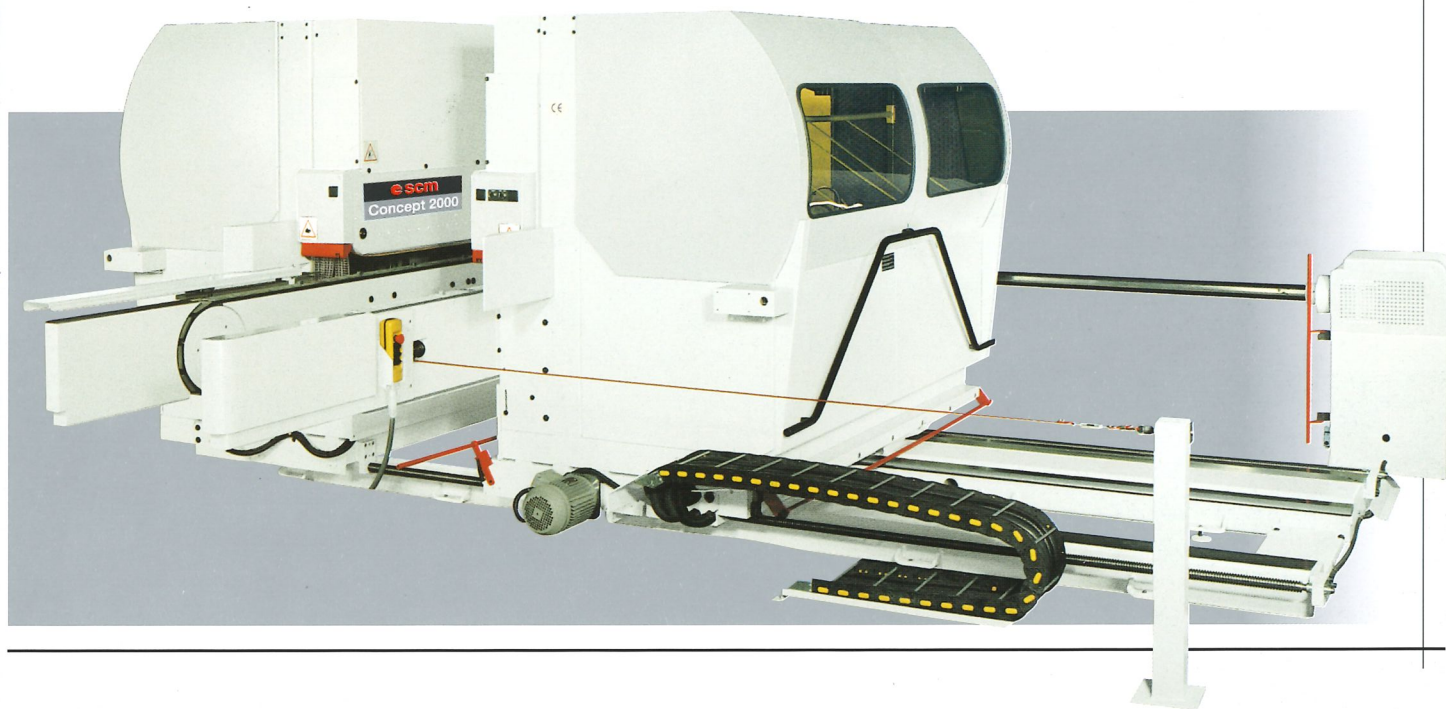

Concept 1000

Squadratrice monolaterale automatica a composizione modulare

Automatic single end tenoner with modular composition

Einseitiger Profiler- und Zapfenschneidautomat mit modularer Konfiguration

Tenonneuse monolaterale automatique à composition modulaire

Esquadradora espigadora monolateral automática con composición modular

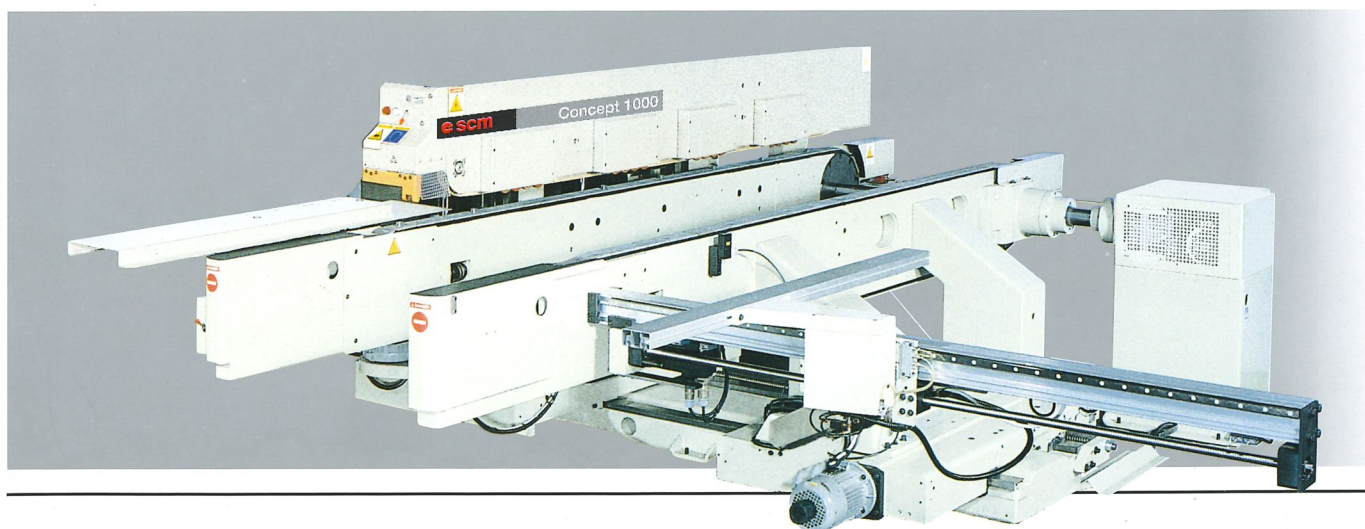

**Macchine classiche
per la falegnameria artigiana**

**Classical machines
for individual woodworkers**

**Standardmaschinen
für Handwerksbetriebe**

**Machines classiques
pour les entreprises artisanales**

**Máquinas clásicas
para empresas artesanas**



Seghe circolari a lama inclinabile - Circular saws with tilting blade - Kreissägen mit schwenkbarem Sägeblatt - Scies circulaires à lame inclinabile - Sierras circulares con disco inclinabile



Con carro scorrevole da 1500, 3200 e 3800 mm e incisore
With sliding table 1500, 3200 and 3800 mm and scorer
Mit Besäumwagen 1500, 3200 und 3800 mm und Vorritzer
Avec chariot d'équarissage de 1500, 3200 et 3800 mm et inciseur
Con carro de escuadrado de 1500, 3200 y 3800 mm e incisor

SI 450 n/e

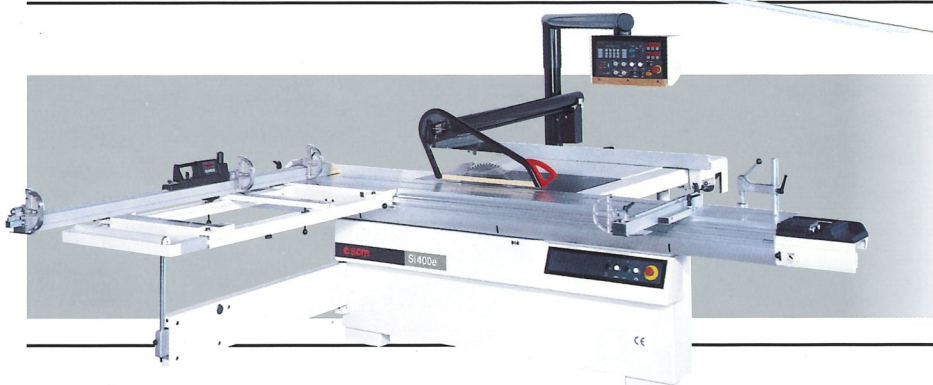

SI 400 n/e

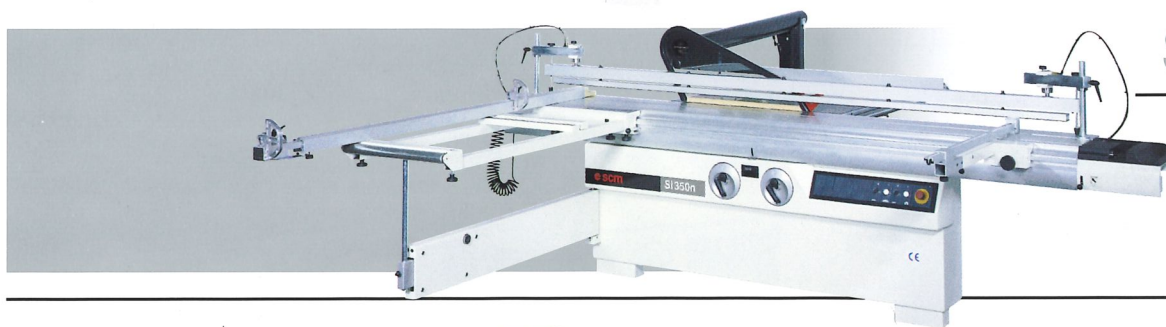

SI 350 n

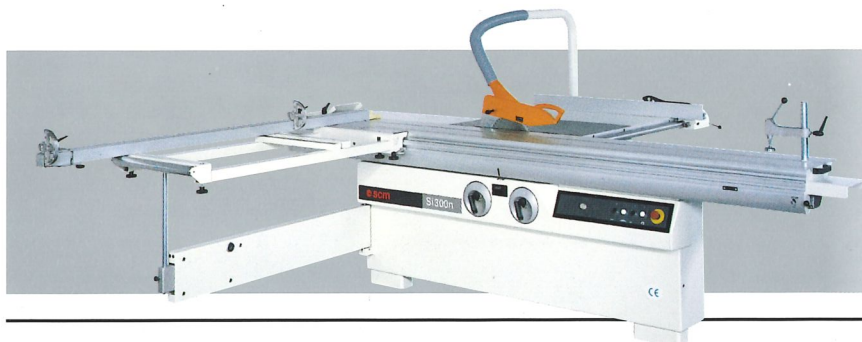

SI 300 n

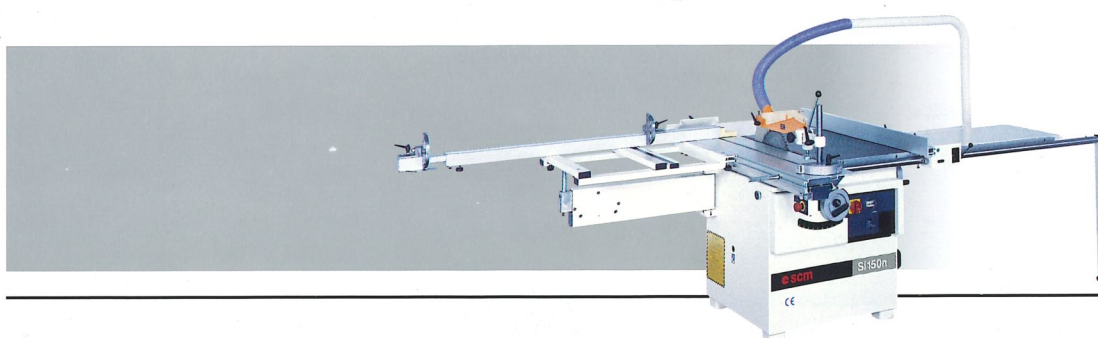

SI 150 n

**Toupiés - Spindle moulders
Tischfräsen - Toupiés - Tupís**

Con albero fijo o inclinable e cambio utensile rapido

With fixed or tilting spindle and rapid tool changer

Mit fester oder schrägstellbarer Spindel und Schnellwerkzeugswechselsystem

Avec arbre fixe ou inclinable et changeur d'outils rapide

De eje fijo ó inclinable y cambio rapido de la herramienta

T 150 class



T 150



T 130 class



T 130 n



T 130 nps



T 110 i



T 110 a



**Pialle a spessore - Thicknessers
Dickenhobelmaschinen - Raboteuses - Regruesos**

Con larghezza piano 630 o 520 mm
With 630 or 520 mm worktable space width
Mit Arbeitsbreite von 630 oder 520 mm
Avec largeur table de 630 ou 520 mm
Con anchura de mesa de 630 ó 520 mm

S 630



S 520



**Pialle a filo - Surface planers
Abrichtmaschinen - Dégauchisseuses - Cepilladoras**

Con larghezza piano 520 o 410 mm
With 520 or 410 mm worktable space width
Mit Arbeitsbreite von 520 oder 410 mm
Avec largeur table de 520 ou 410 mm
Con anchura de mesa de 520 ó 410 mm

F 520



F 410



Combinata filo spessore- Surface-thicknessers - Kombinierte Abricht- und Dickenhobelmaschinen
Dégauchisseuses raboteuses - Combinadas cepillo-regrueso

Con larghezza piani 520 o 410 mm
With 520 or 410 mm worktable space width
Mit Arbeitsbreite von 520 oder 410 mm
Avec largeur des tables de 520 ou 410 mm
Con anchura de mesas de 520 ó 410 mm

FS 520



FS 410



Multilame - Multi blade rip saws
Vielblatt- und Besäumkreissägen - Déligneuses multiples - Sierras multiples

M3

Con larghezza tappeto da 300 mm
With feedtrack space width 300 mm
Mit Vorschubteppischbreite von 300 mm
Avec largeur du tapis d'avance 300 mm
Con ancho de la cadena de arrastre 300 mm



Combinata sega toupie - Combination saw and spindle moulders
Kombinierte Säge- und Fräsmaschinen - Combinées scie-toupie - Combinadas sierra-tupí

Con carro scorrevole da 1500 o 3200 mm e incisore
With sliding table 1500 or 3200 mm and scorer
Mit Besäumwagen 1500 oder 3200 mm und Vorritzer
Avec chariot d'équarissage de 1500 ou 3200 mm et inciseur
Con carro de escuadrado de 1500 ó 3200 mm e incisor



SI 16 T

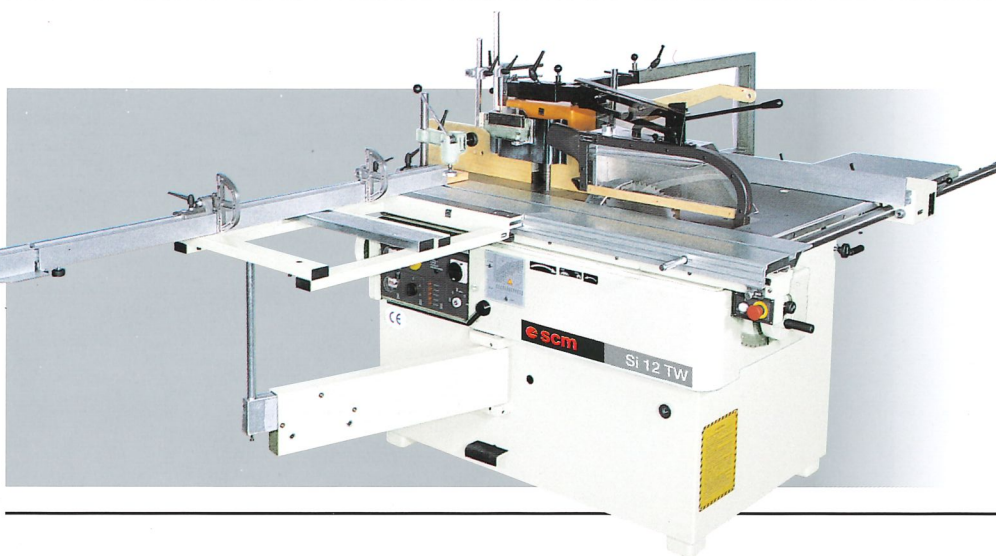

SI 12 TW

Fresatrici verticali - Routers
Kopieroberfräsen - Défonceuses verticales - Fresadoras verticales

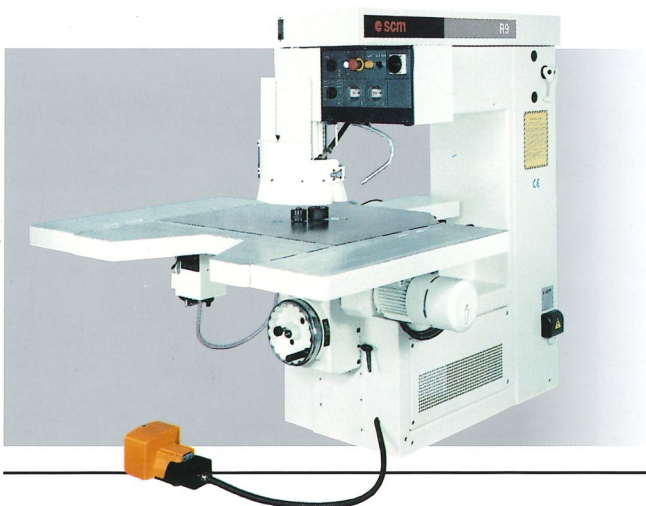

R9

Con copiatore automatico e sottosquadro
With automatic copying and undercut device

Mit automatischer Kopier-
und Profilunterfräsvorrichtungen

Avec copieur automatique
et dispositif pour moulurage des bords

Con copiadador automático y dispositivo
para escuadrar debajo de la mesa

Centri di sezionatura

Panel sizing centres

Plattenaufteilanlagen

Centres pour sciage de panneaux

Centros de corte para tableros



Sigma A/C/EC

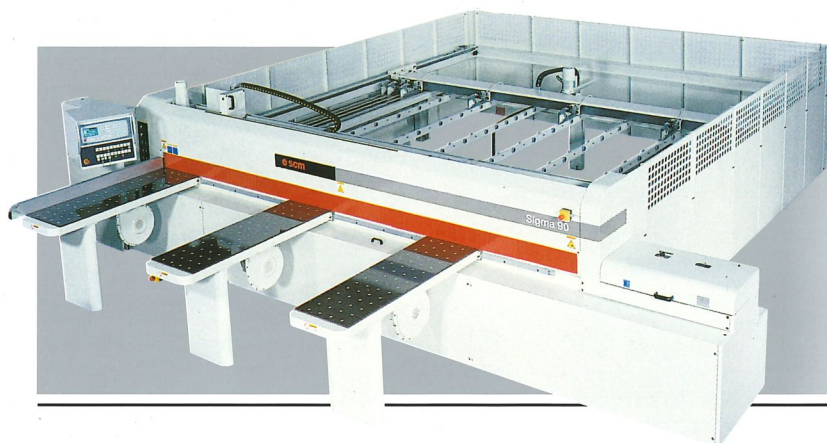

Con pinze e sporgenza
max. lama 65 e 90 mm

With clamps and max.
blade projection 65 and 90 mm

Mit Spannzangen und max.
Sägeblattüberstand 65 und 90 mm

Avec pinces et sortie maxi
lame 65 et 90 mm

Con pinzas y salida max.
de sierra 65 y 90 mm

Sigma D/P

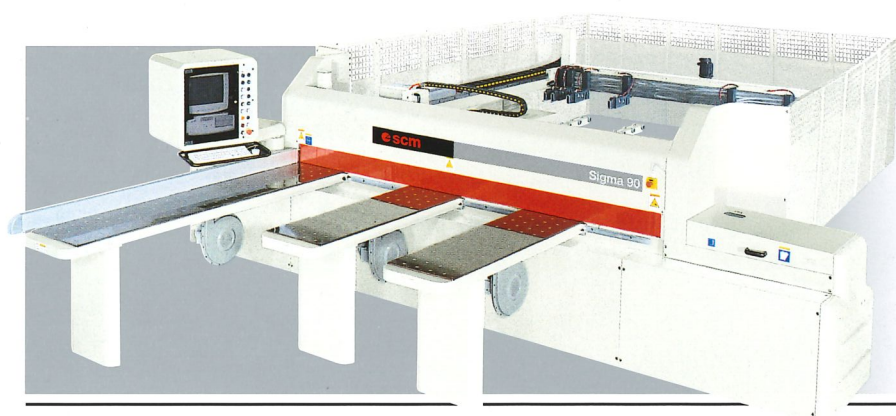

Con pinze e sporgenza
max. lama 90 mm

With clamps and max.
blade projection 90 mm

Mit Spannzangen und max.
Sägeblattüberstand 90 mm

Avec pinces et sortie
maxi lame 90 mm

Con pinzas y salida
max. de sierra 90 mm

Sigma plus D/P

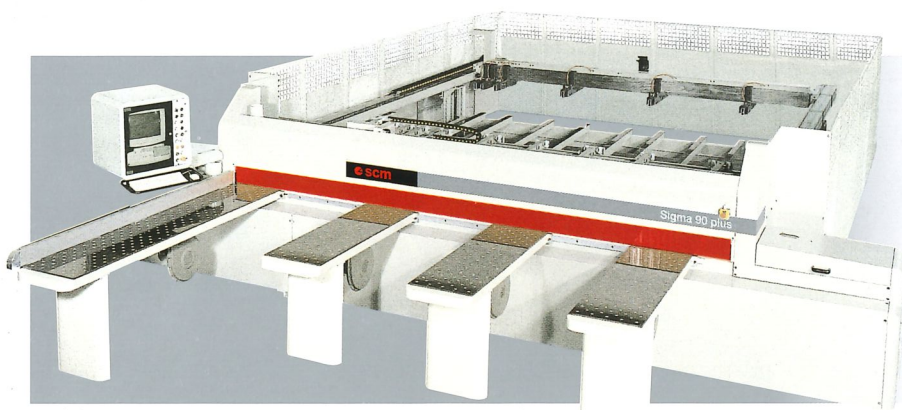

Con pinze e sporgenza
max. lama 90 mm e 115 mm

With clamps and max.
blade projection 90 mm and 115 mm

Mit Spannzangen und max.
Sägeblattüberstand 90 mm und 115 mm

Avec pinces et sortie
maxi lame 90 mm et 115 mm

Con pinzas y salida
max de sierra 90 mm y 115 mm

Sigma evolution D/P

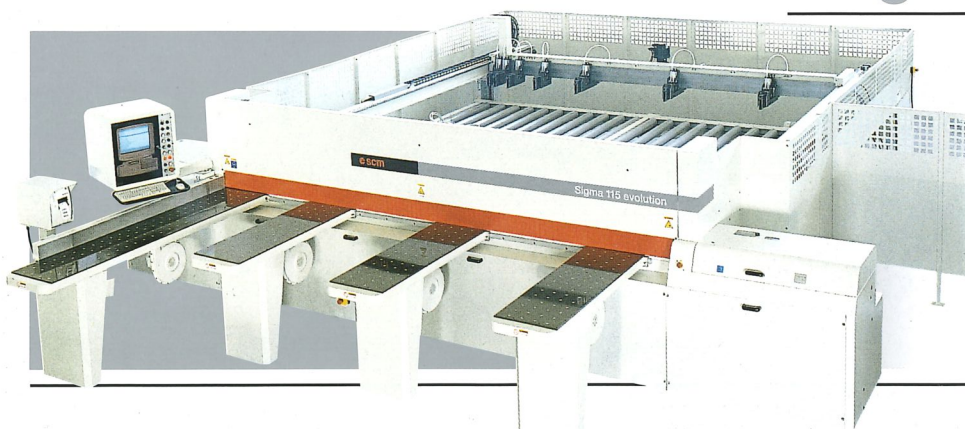

Con pinze e sporgenza
max. lama 115 mm

With clamps and max.
blade projection 115 mm

Mit Spannzangen und max.
Sägeblattüberstand 115 mm

Avec pinces et sortie
maxi lame 115 mm

Con pinzas y salida
max. de sierra 115 mm

Bordatrici monolaterali automatiche
Automatic single sided edge banders
Einseitige Kantenanleimautomaten
Plaqueuses de chants automatiques monolatérales
Chapadoras automáticas monolaterales



Bordatrici industriali per bordi dritti e soft-formati - Industrial edge banders for straight and softformed edges
Industrielle Kantenanleimautomaten für gerade und softforming Kanten - Plaqueuses de chants industrielles pour chants droits et soft-formés - Chapadoras industriales para cantos rectos y soft-formados

Olimpic N 300

Con pressore a rullini.
Max. spessore bordo 30 mm.

With roller presser.
Max. edge thickness 30 mm.

Mit Andruckrollen.
Max. Kantenstärke 30 mm.

Avec presseur à rouleaux.
Epaisseur maxi du chant 30 mm.

Con presor de rodillos.
Max. espesor del canto 30 mm.

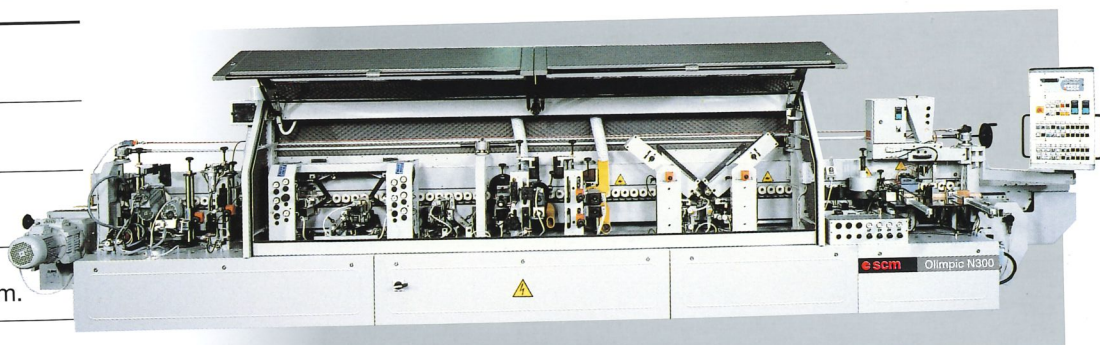

Bordatrici industriali per bordi dritti - Industrial edge banders for straight edges
Industrielle Kantenanleimautomaten für gerade Kanten - Plaqueuses de chants industrielles pour chants droits
Chapadoras industriales para cantos rectos

Olimpic S220

Max. spessore bordo: 20 mm

Max. edge thickness 20 mm

Max. Kantenstärke 20 mm

Epaisseur maxi du chant 20 mm

Max. espesor del canto 20 mm

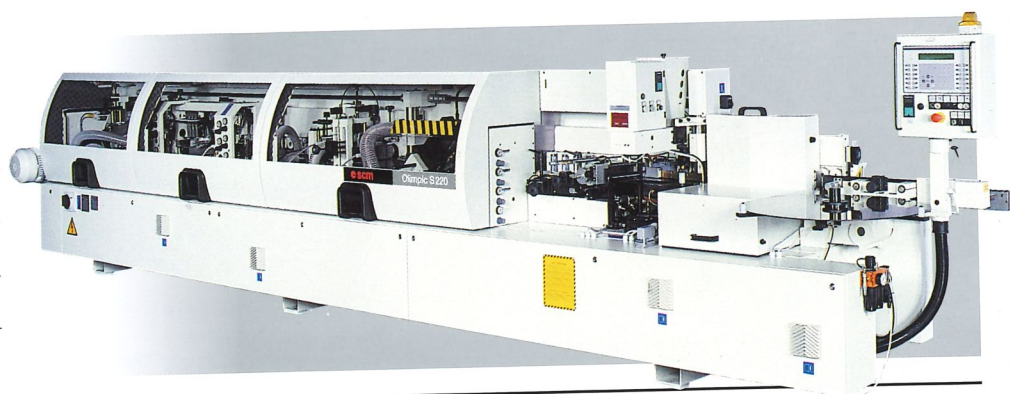

Olimpic S212

Max. spessore bordo 15 mm

Max. edge thickness 15 mm

Max. Kantenstärke 15 mm

Epaisseur maxi du chant 15 mm

Max. espesor del canto 15 mm

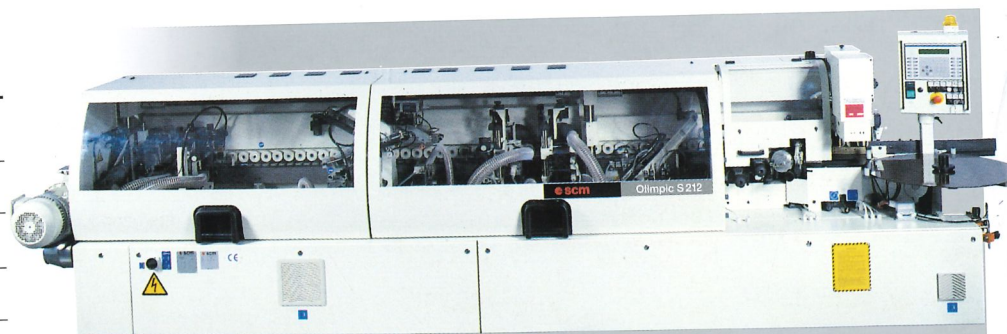

Bordatrici compatte per bordi diritti - Small edge banders for straight edges
Kleine Kantenleimautomaten für gerade Kanten - Petites plaqueuses de chants pour chants droits
Pequeñas chapadoras para cantos rectos



K 208

Max. spessore bordo 10 mm

Max. edge thickness 10 mm

Max. Kantenstärke 10 mm

Epaisseur maxi du chant 10 mm

Max. espesor del canto 10 mm



K 203

Max. spessore bordo 5 mm

Max. edge thickness 5 mm

Max. Kantenstärke 5 mm

Epaisseur maxi du chant 5 mm

Max. espesor del canto 5 mm



K 201 / K 201HF

Max spessore bordo 3 mm

Max. edge thickness 3 mm

Max. Kantenstärke 3 mm

Epaisseur maxi du chant 3 mm

Max espesor del canto 3 mm

Macchine semiautomatiche accessorie - Semi automatic machines for complementary functions
Halbautomatische Maschinen für zusätzliche Funktionen - Machines semi-automatiques pour fonctions complémentaires
Máquinas semi-automáticas para funciones complementarias



Contura - Pratika

Bordatrice e rifilatrice manuale per pannelli diritti, rotondi e sagomati

Edge bander and manual trimmer for straight, round and shaped panels

Kantenleimmaschine und manuelle Bündigräsmaschine für gerade, abgerundete und profilierte Platten

Plaqueses de chants et Affleureuse manuelle pour panneaux droits, ronds et profilés

Chapeadora y Refiladora manual para tableros rectos, redondeados y perfilados

Centri di fora-fresatura a CNC e foratrici semiautomatiche

CNC boring and routing centres and semi-automatic boring machines

CNC- Bohr- und Fräszentren und halbautomatische Bohrautomaten

Centres de perçage et de fraisage à CN et perceuses semi-automatiques

Centros de taladro y fresado a CNC y taladros semi-automáticos

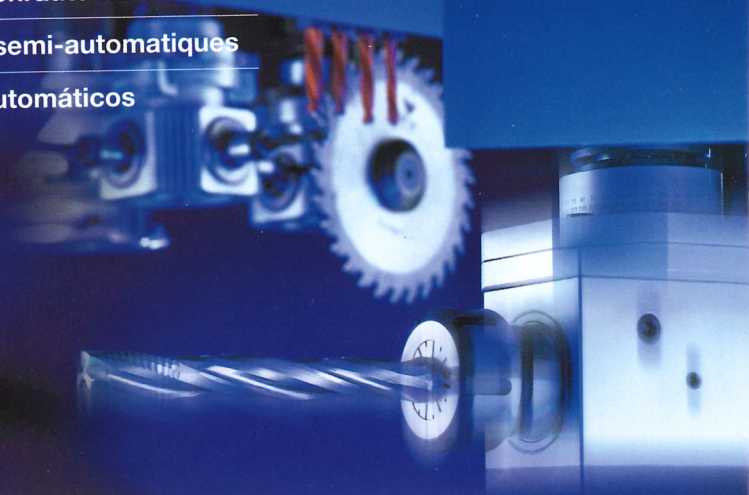

Tech Serie 90

Centri di fora-fresatura a CNC con doppio campo di lavoro e cambio utensile
CNC boring and routing centres with alternated work process and automatic tool changer
CNC-Bohr- und Fräszentren mit wechselseitiger, unterbrechungsloser Bearbeitung und automatischem Werkzeugwechsler
Centres de perçage et de fraisage à CNC avec zone d'usinage pendulaire et changeur d'outils automatique
Centros de taladro- fresado a CNC con doble campo de trabajo y cambio herramienta automático

Tech 99L

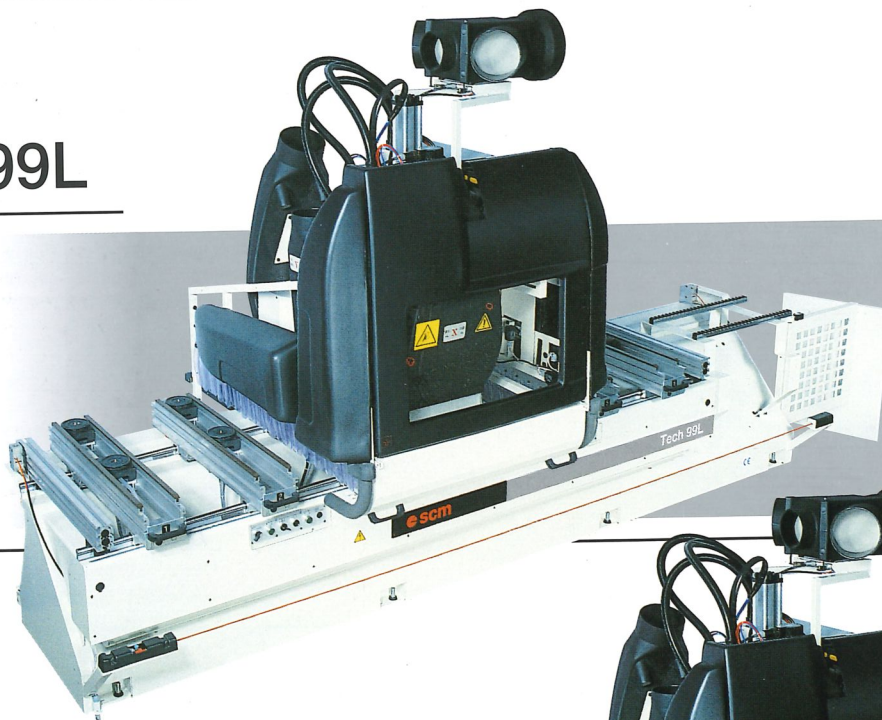

Tech 95L

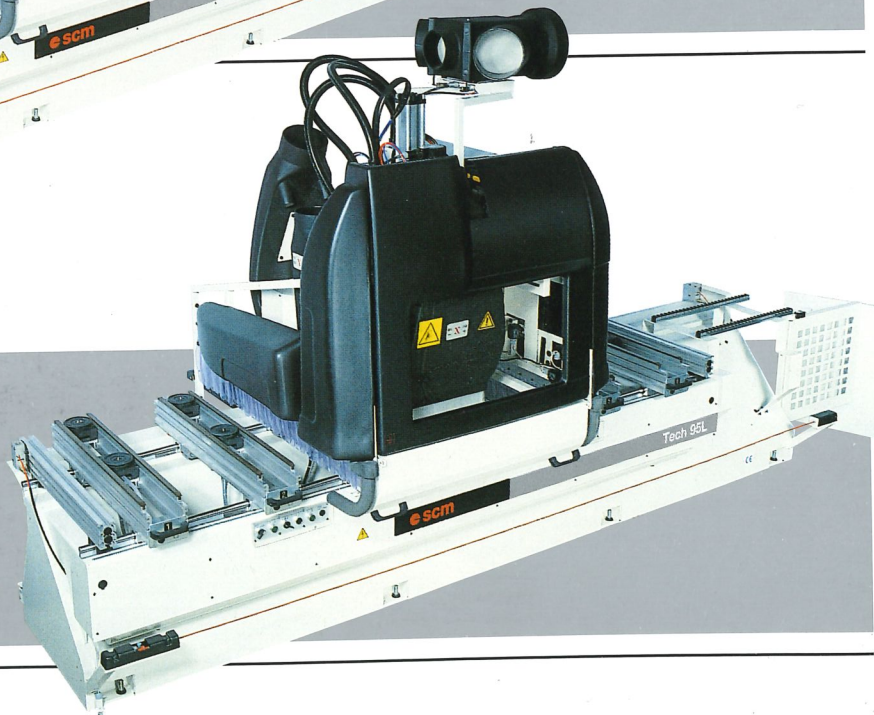



Tech 80

Centri di fora-fresatura a CNC con doppio campo di lavoro

CNC boring and routing centres with alternated work process

CNC-Bohr- und Fräszentren mit wechselseitiger Bearbeitung

Centres de perçage et de fraisage à CNC avec zone d'usinage pendulaire

Centros de taladro- fresado a CNC con doble campo de trabajo

Centri di foratura universale a CNC - Universal CNC boring centres - Universal- CNC- Bohrzentren
Centres de perçage universel à CN - Centros de taladro universal a CNC

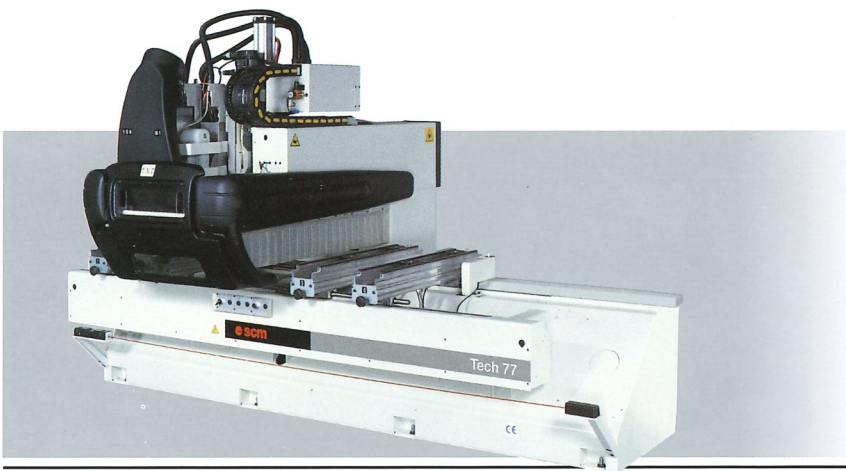

Tech 77

Centri di foratura universale a CNC con campo di lavoro fino a 2800 mm

CNC universal boring centres with working area up to 2800 mm

Universal-CNC- Bohrzentren mit Arbeitsbereich bis 2800 mm

Centre de perçage universel à CNC avec zone d'usinage jusqu'à 2800 mm

Centro de taladro a CNC con campo de trabajo hasta 2800 mm

Foratrici semi automatiche - Semi automatic boring machines
Halbautomatische Bohrautomaten - Perceuses semi-automatiques - Taladros semi-automáticos



Startech

Macchine foratrici monotesta automatiche a 23 o 29 mandrini

Automatic single head boring machine with 23 or 29 spindles

Bohrautomat mit Einzelkopf mit 23 oder 29 Spindeln

Perceuses automatiques monotête avec 23 ou 29 broches

Taladros automáticos de único cabezal con 23 o 29 porta-brocas



Top

Macchine foratrici monotesta automatiche a 35 mandrini con la caratteristica foratura dall'alto.

Automatic single head boring machine with 35 spindles for boring from above.

Automatische Dübelbohrmaschine mit Einzelkopf und 35 Spindeln für Bohrungen von oben.

Perceuses automatiques monotête avec 35 broches pouvant percer par le dessus.

Taladros automáticos de único cabezal con 35 porta-brocas para taladrado superior.

Lineteck

Foratrici semiautomatiche a 2 teste verticali dedicate per l'esecuzione di doppie file di fori per ripiani regolabili

Semiautomatic boring machine with 2 heads to carry out 2 boring rows for adjustable shelves

Halbautomatische Reihenbohrmaschine mit zwei vertikalen Bohrköpfen für die Ausführung von gleichzeitigen Doppelreihenbohrungen für Fächerträger

Perceuses semi-automatiques à 2 têtes verticales pour l'exécution d'une double rangée de perçages pour étagères réglables

Taladros semiautomáticos múltiples con 2 cabezales verticales para la ejecución de dobles filas de taladros para estanterías regulables



Multitech

Foratrici semiautomatiche di facile utilizzo a 3 teste (2 verticali e 1 orizzontale)

Semiautomatic boring machine easy to use with 3 heads (2 vertical heads and 1 horizontal head)

Halbautomatische Reihenbohrmaschine mit zwei vertikalen und einem horizontalen Bohrkopf

Perceuses semi-automatiques faciles à utiliser à trois têtes (2 verticales et 1 horizontale)

Taladros semiautomáticos de fácil utilización con 3 cabezales (2 verticales y 1 horizontal)



Calibratrici levigatrici automatiche

Automatic calibrating and sanding machines

Kalibrier- und Feinschleifautomaten

Calibreuses ponceuses automatiques

Lijadoras calibradoras automáticas

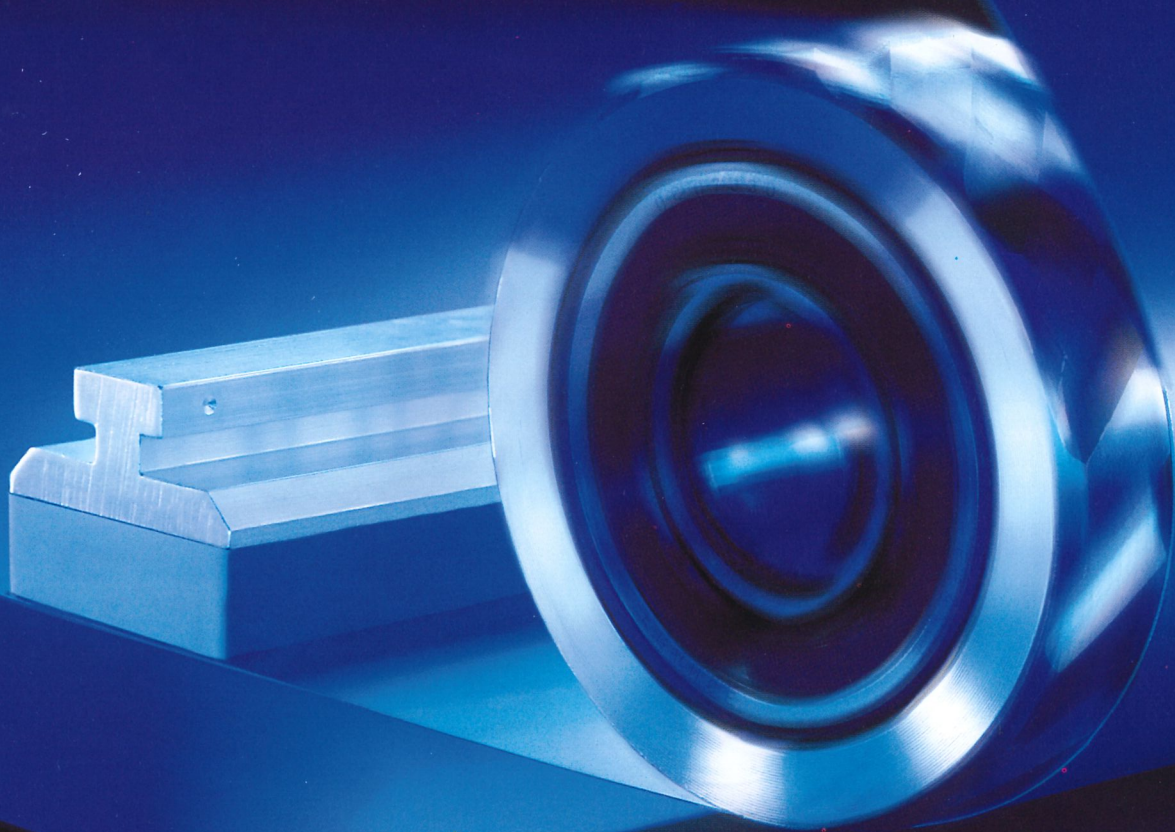

Con 2, 3 o 4 gruppi operatori - With 2, 3 or 4 working units
Mit 2, 3 oder 4 Arbeitsaggregaten - Avec 2, 3 ou 4 groupes opérateurs - Con 2, 3 ó 4 grupos operadores

Sandya 50



Sandya 40



Sandya 20



Sandya 10S



Con 1 o 2 gruppi operatori - With 1 or 2 working units
Mit 1 oder 2 Arbeitsaggregaten - Avec 1 ou 2 groupes opérateurs - Con 1 ó 2 grupos operadores

Sandya 5



Sandya 3



Sandya 1K



Sandya Win



www.scmgroup.com

e-mail: scm@scmgroup.com

NEWS

scm e group

the world's best selling woodworking machines

Products

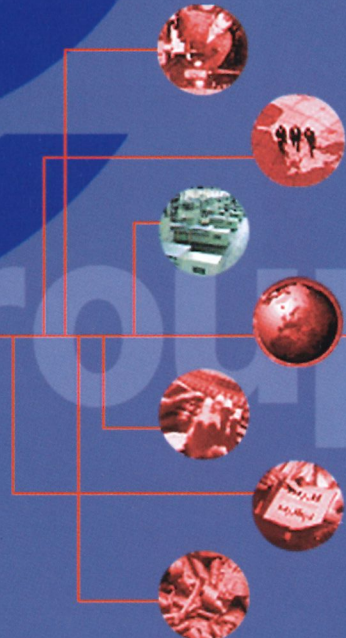

scm e group

Company Profile | Companies | Products | In the World

Research & Development | Training | Exhibitions | News

The World's Best-Selling Woodworking Machinery

Two million machines operating in over 120 countries. SCM Group products are distributed worldwide through subsidiaries operating in Germany, France, Spain, Great Britain, Italy, Switzerland, Romania, Bulgaria, Austria, Canada, USA, Singapore, Hong Kong, and Japan. Its global presence is also supported by a network of 250 qualified sole agents and distributors.

Work centres
Sawing machines

Thru-hole and moulders
Soring machines

Sanding machines
Routing machines

Edgebanding machines
CNC work centres

Panel systems
Industrial ma

MiniMax
Sempro ma
Hobby ma

DMC
MORBIDELLI
MAHROS
ROUTECH

scm e group

Company Profile | Companies | Products | In the World

Research & Development | Training | Exhibitions | News

RECORD 240

Flexible machining center with high versatility

RECORD 240 is a new machining center available in a wide range of configurations, dedicated to a vast range of machining operations and capable of dealing with all machining requirements.

The greater skill to modular and, depending on machining requirements, may consist:

- Developed by SCM, this electro-spindle is fitted with a VHSR 3 F quick-release taper for maximum rigidity and precision during operations and has a power of up to 16 kW at 6000 rpm to guarantee maximum performance, especially with large tools.
- The new RAPID 12 tool changer means that all the tools normally required for the majority of the components are available on the machine.
- With the TR 1, TR 2, TR 3 additional tool changes, more than 40 tools are

scm e group

Company Profile | Companies | Products | In the World

Research & Development | Training | Exhibitions | News

Company Profile

Today, SCM Group is a world leader in the woodworking machinery and system sector. Two million machines installed and operating in 120 countries, 12 factories, and 70% of the production in export.

The origins of SCM Group, date back to 1932 when the late father, Nicola Geronzi and Luciano Anelli, established the first professional machine and an iron factory in 1932. The electric saw blade and the woodworking machinery sector. The first multipurpose machine engineered by the young Giuseppe Geronzi, which was produced on industrial scale for the first time, was soon successfully distributed worldwide under the trade name *Automatica*.

The quality of the machinery, offered at advantageous prices because produced on industrial scale, played a fundamental role in organizing important distribution channels and setting up a network of distributors and agents all over the world, first in Europe and finally in 120 countries worldwide.

Together with the strengthening of marketing operations, the Group decided to implement its line of products. In the 1970s the efforts were directed towards the construction of semi-automatic and fully automatic Customer operation, an overall corporate policy, of great primary importance in anticipating the solution to the client's problems and, from the 1980s, electronics became an integral part of the product. Joint ventures and local branches allow a fast and efficient answer to service and after-sales assistance.

scm e group

Company Profile | Companies | Products | In the World

Research & Development | Training | Exhibitions | News

The Strength of a Large Group of Specialists

2,000 employees, 12 factories and a export level which accounts for 70% of its production.

SCM GROUP operates through a number of highly specialized brands:

SCM the founder company which produces solid wood and panel processing machinery for the medium and large industries; **MORBIDELLI** being machine and systems; **MAHROS** CNC router and machining centres; **ROUTECH** ENGINEERING, integrated systems for reworking; **DMC** handling machines; **SEMIPRO** workshop reworking machines. The production process is completely integrated with 2 floors for cast iron, a dedicated and highly automated factory for the production of electric and electronic components, a study & research division and a vocational training centre.

scm e group

Company Profile | Companies | Products | In the World

Research & Development | Training | Exhibitions | News

scm group in the world

Close to our customers in 120 countries

SCM Group products are distributed in 120 countries and throughout the world by agents and dealers backed up by subsidiaries currently operating in Germany, France, Spain, Great Britain, Italy, Switzerland, Romania, Bulgaria, Austria, Canada, USA, Singapore, Hong Kong, and Japan (with 4 sales offices in China) and several.

Through this distribution network, comprising 350 dealers and agents with over 1,200 sales outlets, the SCM Group is able to offer its clientele a complete before and after-sale service.

Please contact us at our subsidiaries or directly at our companies. We will be pleased to give you all the information required on our products and sales points nearest to you.

E-mail: scm@scmgroup.com

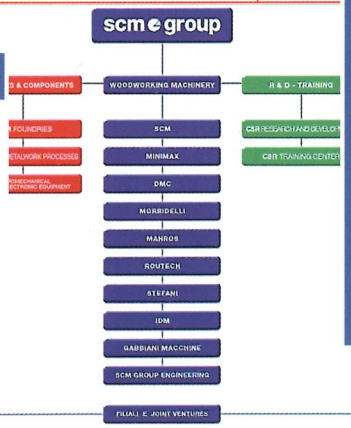

In the mid-1980s, SCM Group, with the acquisition of companies already well consolidated in the production of panel machinery, created the conditions to give itself an organic form and a fully integrated system. Between 1987 and 1992, six companies leaders in their respective market sectors, became part of SCM Group. The acquisition of the Italian company, with the Faculty of Engineering and Agriculture of the University of Bologna.

SCM Group is a group and determined to complete its tasks on the economic scenario of the third Millennium.

ESD



SCM GROUP spa

SCM - Via Casale, 450 - 47827 Villa Verucchio (RN) - Italy - Tel. +39/0541/674111 - Fax +39/0541/674274

SCM - Via Emilia, 71 - 47900 Rimini - Italy - Tel. +39/0541/700111 - Fax +39/0541/700283

www.scmgroup.com - e-mail: scm@scmgroup.com