



21 JUN 2007



THE PROGRAMME



Machines + tools
for woodworking

FELDER

FORMAT

Hammer

2006/07



Tradition

400 years of family tradition in metal forging



In the beginning ...

In 1956 Johann Felder presented the first combination wood working machine.

1956



2006

50 years of innovation

For the last 50 years it has been our goal to construct the very best wood working machinery

From concept to delivery / technical innovation	2
Machine components	4
Brand philosophy	6
FORMAT-4-machines – the new dimension	8
FELDER-series 900 – for small business to large industry	18
FELDER-series 700 – for the professional and everyday woodworker	26
FELDER- series 500 – top performance at affordable prices	34
FELDER Accessory Machines	40
HAMMER machines – for hobby, craft work and small businesses	42
Bandsaws	50
Tools, fittings and extractor equipment	52
5 good reasons	54
Satisfied customers	55
Investment goods and leasing	56



For generations working with metal, forging and machine construction has been a tradition within the Felder family

In 1956 Johann Felder founded today's company. The first Felder wood working machines were manufactured in the work shop at the family home in Absam.

The huge success of the Felder products on the global market, led to constant expansion. In 1981 the company relocated to Hall in Tirol, where the company is based to this day.

Today 50 years after the foundation of the company, the Felder Group employs over 350 workers.

The successful combination of highly developed technical products and production solutions makes the Felder Group leading world wide provider in the standard wood working machine market.

Thousands of satisfied customers and numerous awards e.g. the Bayrische Staatsprize, the -IF- design award or the Adolf-Loos-prize only confirm our desire to construct the best of woodworking machinery.

The company, Felder KG in „Hall in Tirol“.



Machines + tools
for woodworking

FELDER

FORMAT

Hammer

NI MASCHINEN
MARKT

f felder
components



Tradition – Innovation – Perfection: A risk-free decision

Woodworking machines from the FELDER-GROUP are the result of the 50 years experience in machine construction and a desire to improve even further.

Daily contact with woodworkers all over the world and continuous innovative developments make Felder woodworking machines best-sellers worldwide.

Tradition

Machine construction and metal processing have been tradition in the Felder family for generations. Our wood working machines are 100% developed and produced at the Felder Group factories in Hall in Tyrol.

The areas of research and development, production techniques and assembly, marketing, advertising, sales and service, as well as apprentice training and schooling are traditionally the most important pillars of our international enterprise.

Innovation

With many patents, highly developed products and innovative detailed solutions, the Felder group is the leading provider world wide in the standard wood working machinery sector.

We know what you expect from woodworking machinery and are always ready for a further challenge to create new innovative product solutions.

Perfection

Products from Felder stand for first class quality and the best price performance ratio!

Our precise production process, strict quality, safety insurance and also the constant training and further education of our employees, ensure that you as a customer and user can expect a woodworking machine with outstanding quality and many, many years of precision.



FELDER cutterblock system

A first class tried and tested system!

Quick change system for moulder spindle

Rearward tilt improves both safety and user comfort

Masterclass format sliding table

Perfection through quality and precision.

6 year guarantee backs up the durability.

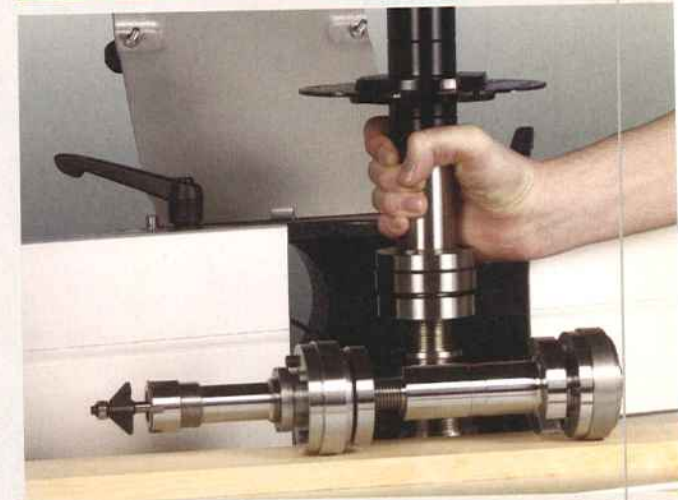
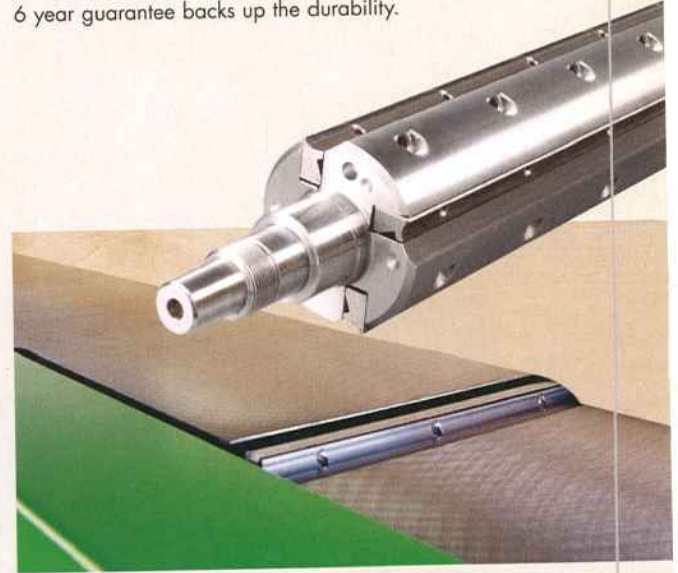

A risk-free decision

Woodworking machinery from the Felder group is custom made to meet your exact requirements. Performance, precision, versatility, optimum user-friendliness and processing, best describe the performance that you can expect from our wood-working machinery.

100% developed and produced by FELDER.

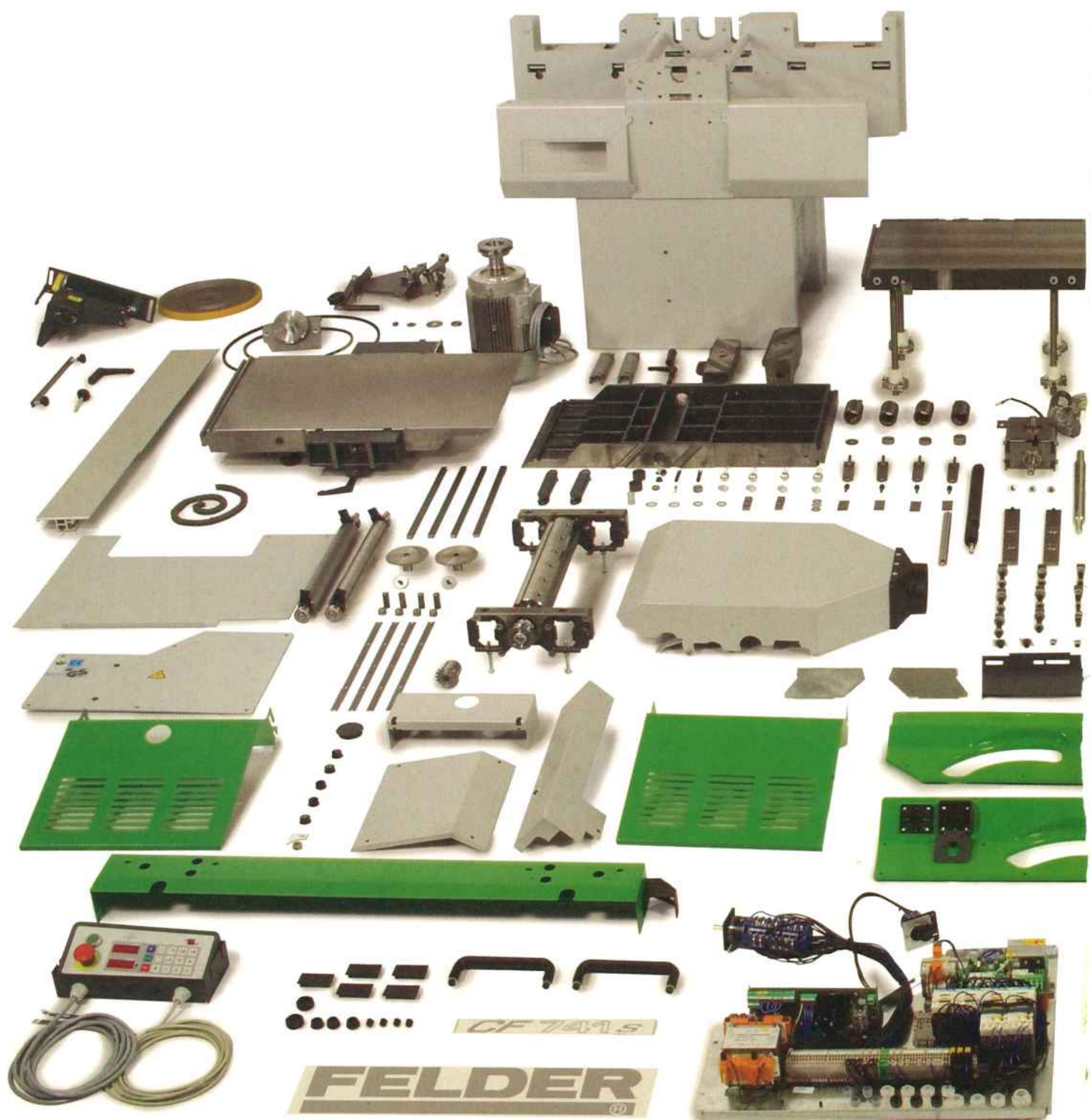

Cutting-edge technology.
Numerous international patents.
Premium materials used to manufacture top quality products.

Woodworking machines from the Felder Group are amongst the most popular. Worldwide.

CF 741 S Professional - 5271 Individual parts

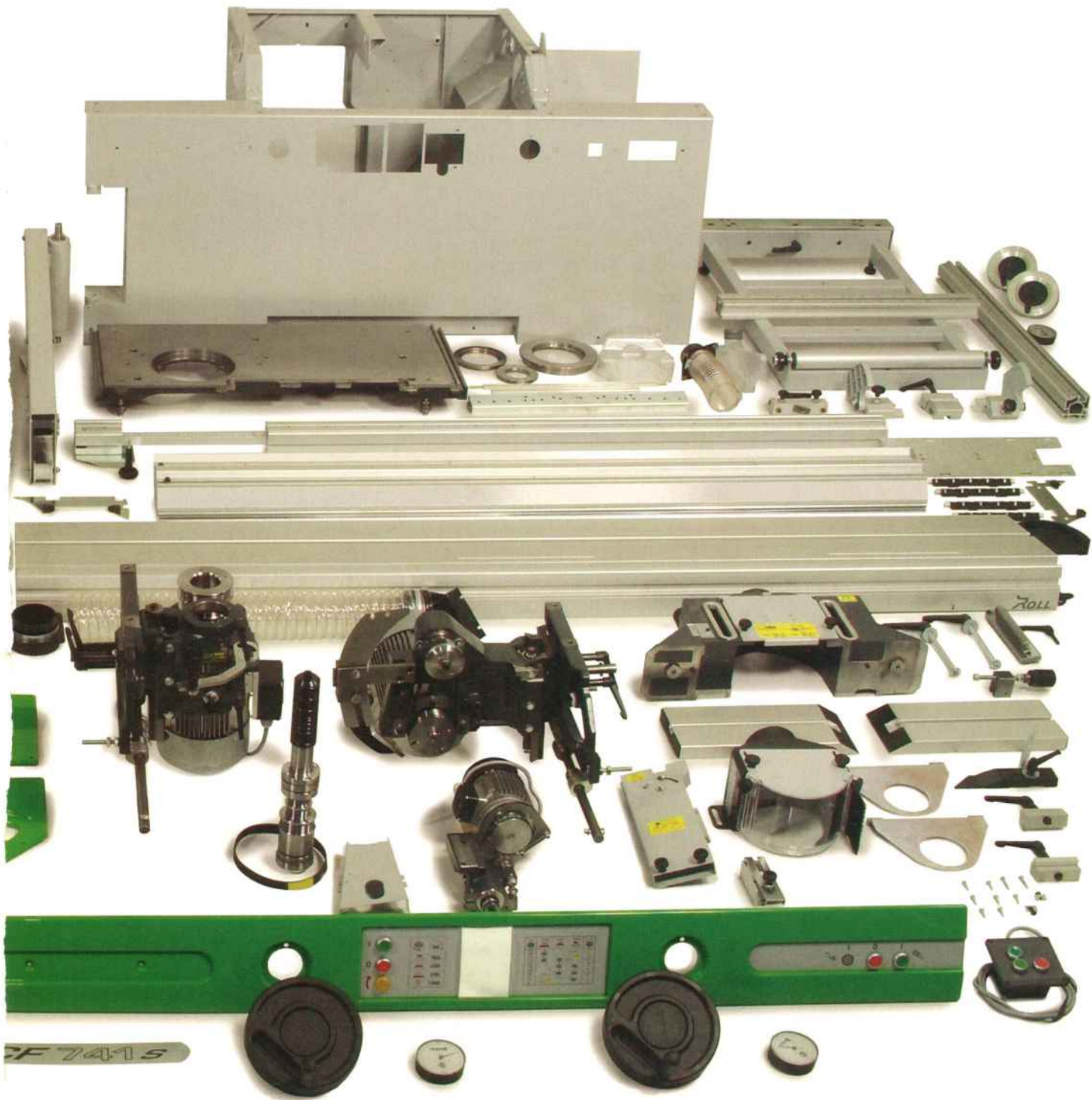

Our philosophy: To tailor the machine to your exact requirements.

Our selection ranges from the multi-purpose combination machine to the specific solo machine and on to our magnificent **FORMAT-4 x-motion** with CNC- operating controls.

Our range has something for everyone.



FORMAT[®]

The range for the highest demands in trade and industry

FELDER[®]
SERIE 900

For small business to large industry

FELDER[®]
SERIE 700

For the professional and everyday woodworker

FELDER[®]
SERIE 500

Top performance at affordable prices

Hammer

The obvious choice

Top-end woodworking machinery for trade and industry

The Format-4 machines are the flagships of the Felder Group. They supply you with first class design and precision accuracy and are very user friendly, with the most exclusive standard equipment at an extremely good price.



The FELDER Serie-900 Classic Woodworking Machinery range has been developed specifically for hard daily industrial use.

Precision, versatility and durability encompassed in a modern ergonomic design. There is simply no tougher more up to date range of machines available in this class.



More than 50 years machine construction experience go into the perfectly designed components of every FELDER!

Our company policy: To produce efficient, reliable and technologically leading machines that satisfy every wood working professional.



The new 500 Series: Top performance at affordable prices!

The new 500 series. The range for wood working professionals, with its high quality machine components, top efficiency and absolute reliability, all at a great price.



Big on performance, easy on the budget

Hammer are cost effective woodworking machines which are developed and manufactured at our factory in Hall in Tyrol, Austria. High performance machinery which won't hurt your budget - the ideal choice for getting started.



FORMAT⁴

The range for the highest demands in trade and industry

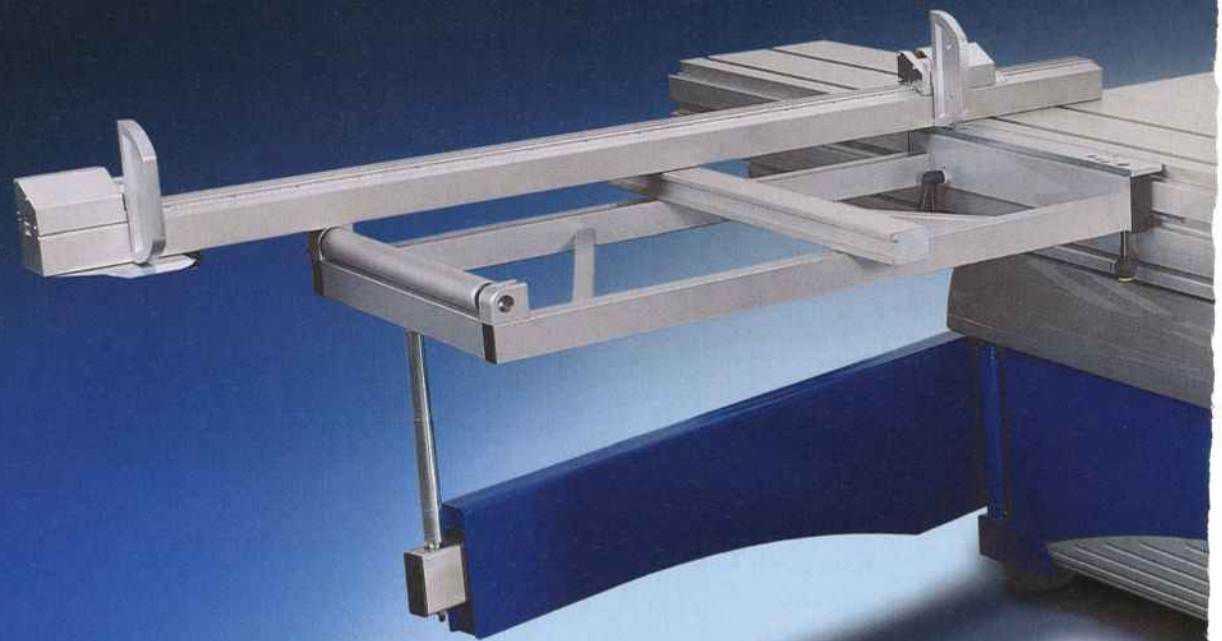

The outward design reflects the inner quality and has won one of the top international design awards.

kappa x-motion - Technology, operating convenience and performance without compromise

If you want the best from the house of Format-4, the kappa x-motion with CNC-drive control and CNC-Rip fence adjustment fits the bill.

With the kappa x-motion you are not only assured of cutting edge technology, operating convenience and reliability but also outstanding value for money.

The CNC-Central Command on the kappa x-motion is clearly and ergonomically designed. This allows for fast and easy adjustment of settings.

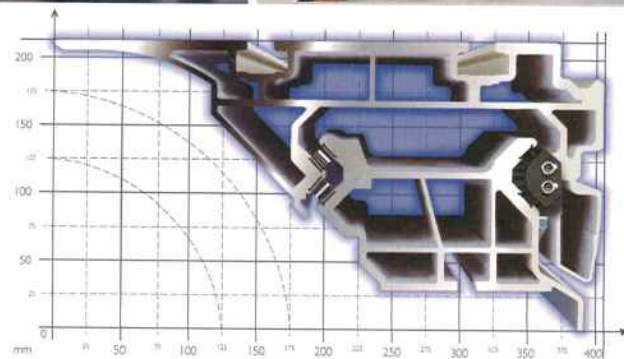



kappa 450 - the FORMAT-4 with the optimal cutting height

This sliding table saw exceeds standards of the highest caliber! 155 mm or 170 mm cutting height with a sawblade of 450 mm means that, at a 45° angle the sawblade remains at an impressive cutting height of 110 mm or 119 mm!

FORMAT-4 kappa 30 and kappa 40 give optimum performance with a cutting height of up to 133 mm.

At first sight, Format-4 sliding table saws reflect our desire for perfection and the courage to find new solutions. Hidden inside the dynamically designed machine chassis you'll find advanced technology and a model of working convenience!

This allows for simple and comfortable use with the utmost safety.

Uncompromising standards and performance (no additional cost): The electrical height and angle adjustment of the sawblade unit, the operating panel with red LED-display for sawblade height, tilt and speed, a tilting telescopic crosscut fence on the outrigger table for mitre cuts and much more.





The solo machines of a special class - with details that fulfill all your requirements

dual 51



A powerful combination: FORMAT-4 dual 51, The surface thickness planer for highly demanding tasks

If any combined surface thickness planer meets high professional demands, then it is the Format-4 dual 51.

In modern woodworking companies nowadays the use of every square meter of valuable production area must be carefully planned. Consequently, the demand for combination machines is very high.

The Format-4 dual 51 is of extremely compact design. The space saving construction of the jointing fence using a parallelogram system is proof of it.

There is little change-over time from surface planing to thickening as a result of modern operating techniques like the dual spring supported elevation of the planer tables and electrical thicknesser table adjustment.

plan 51



Components from the most up to date performance technology and design – plan 51 Planer

The surface planer plan 51 uses the Format-4 cutterblock with a diameter of 120 mm and 4 or 6 knife system, providing efficiency, precision and user friendliness all in one.

Long, solid cast iron planer tables with easy quick adjustment of the cutting depth from the planer table in-feed position. The tilting planer fence and the Format-4 cutterblock system make your plan 51 a top class surface planer.

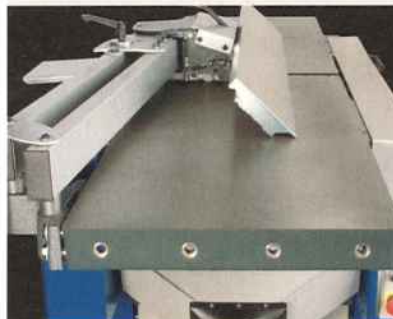
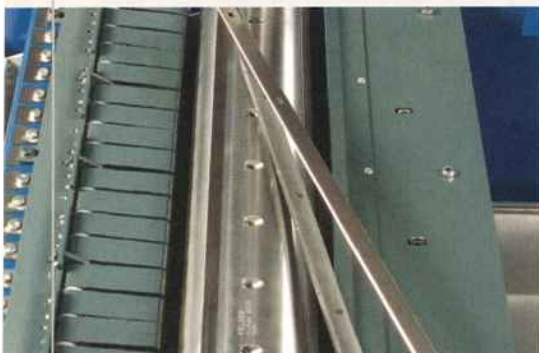

exact 51



Even more precision and quality - exact 51 thickness planer

When precision and perfectly thickened results are what you require, you need not look any further than the Format-4 Thicknesser.

Technically superior, simple to operate and built to last. These are the standard qualities in each and every Format-4 Thicknesser. Imagine your perfect thicknesser and then find it with Format-4.



profil 45



Tilting spindle moulder profil 45, unique in power, elegance, performance, and accuracy

The profil 45 spindle moulder is one of our best selling machines, providing unique technical solutions.

It includes the electronically powered MULTI adjustment system for the spindle moulder fence 250 with automatic parallel alignment as well as quick adjustment on the out-feed fence with a digital indicator.

Electrical fine adjustment at the press of a button, accuracy to a tenth of a millimetre, quick spindle exchange system and tool release change in under 10 sec are just a few of the features on a profil 45.

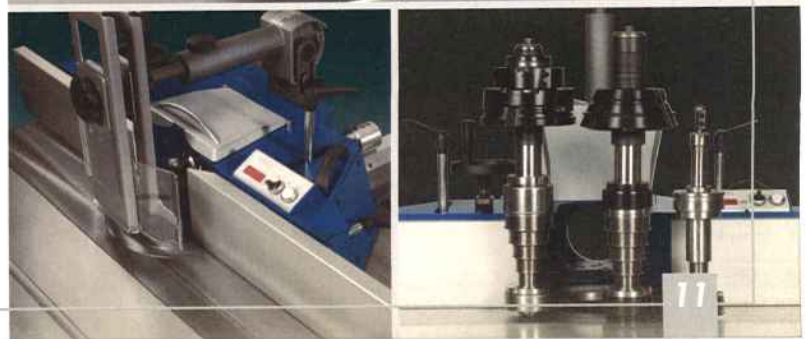

Technical data FORMAT-4

	kappa x-motion	kappa 450	kappa 40	dual 51	plan 51	exact 51	profil 45
Electrics							
Motor power 5.5 HP (4.0 kW) S1	-	S	S	S	S	S	S
Motor power 7.5 HP (5.5 kW) S1	S	O	O	O	O	O	O
Motor power 10.0 HP (7.35 kW) S1	O	O	-	O	O	O	O
Motor power 15.0 HP (11.0 kW) S1, 2-speed moulding 3200/4500 rpm	O	O	-	-	-	-	-
Star-Delta-Start	S	S	S	S	S	S	S
Forward and Reverse Run	-	-	-	-	-	-	S
Variable speed control	O	O	O	-	-	-	O
Surface Planer and Cutterblock							
Anodised surface planer fence 1150 x 170 mm	-	-	-	S	S	-	-
Surface planing width in mm	-	-	-	510	510	-	-
Planer table length in mm	-	-	-	2250	2250	-	-
Planer guard EURO "Standard"	-	-	-	S	S	-	-
4 knife Format-4-system cutterblock	-	-	-	S	S	S	-
6 knife Format-4-system cutterblock	-	-	-	O	O	O	-
4 knife standard cutterblock	-	-	-	O	O	O	-
4 knife TERSA-system cutterblock	-	-	-	O	O	O	-
Thickener and Feed Drive							
Thickening planing width in mm	-	-	-	510	-	510	-
Thickening table length in mm	-	-	-	900	-	900	-
Electric thickener table height control	-	-	-	S	-	S	-
LED Display for thickening table adjustment for Power-Drive D1	-	-	-	S	-	S	-
Position Control for thickening table height Digi-Drive D1 with pre-setting of dimensions	-	-	-	O	-	O	-
Adjustable rollers below the thickening table, adjustment range 0-0.5 mm	-	-	-	O	-	O	-
Rubber infeed and outfeed roller, Sectional pressure bar at infeed side	-	-	-	O	-	O	-
Thickening height 4 mm-254 mm	-	-	-	S	-	S	-
Variable speed drive 4-16 m/min "Vario"	-	-	-	S	-	S	-
Circular saw driving unit							
3-speed moulding 3000/4500/6000 rpm with LED-display on the operating panel	S	S	-	-	-	-	-
3-speed moulding 3500/4500/5500 rpm	-	-	S	-	-	-	-
Electrical tilt adjustment 90°-45°, electrical height adjustment	S	S	S	-	-	-	-
Cutting height compensation when tilting sawblade	S	S	-	-	-	-	-
Sawblade-Ø range in mm	250-450	250-450	250-400	-	-	-	-
Cutting height in mm	155	155	133	-	-	-	-
Cutting height 170 mm	O	O	-	-	-	-	-
Spraying equipment for the processing of non-ferrous metals and plastics	O	O	-	-	-	-	-
Removable flange for slotting tools incl. a set of flanges	S	S	O	-	-	-	-
Rip capacity 800 mm	-	-	S	-	-	-	-
Rip capacity 1000 mm	-	O	-	-	-	-	-
Rip capacity 1250 mm	S	S	O	-	-	-	-
Rip capacity 1600 mm	O	O	-	-	-	-	-
Electronic digital display for rip capacity 800/1000/1250/1600 mm	-	O	O	-	-	-	-
Rip capacity CNC controlled rip fence	S	-	-	-	-	-	-
Overhead saw guard	S	S	S	-	-	-	-
Locking mechanism on front side of machine to tilt away overhead guard	O	O	-	-	-	-	-
Scoring Unit							
Classic scoring unit, 9000 rpm, scoring blade-Ø 120-125 mm, motor power 1.1 kW (1.5 HP)	O	O	O	-	-	-	-
Automatic scoring unit, 9000 rpm, scoring blade-Ø 120-125 mm, motor power 1.1 kW (1.5 HP)	O	O	O	-	-	-	-

	kappa x-motion	kappa 450	kappa 40	dual 51	plan 51	exact 51	profil 45
Panel sizing saw table and rip fence stops							
Saw table extension 600 mm, steel-powder coated	S	S	-	-	-	-	-
Saw table extension, ALU anodised	O	O	-	-	-	-	-
Spindle Moulder Unit and Spindle Fence							
Electric spindle height adjustment	-	-	-	-	-	-	S
5-speed moulding 3500/4500/6000/8000/10,000 rpm	-	-	-	-	-	-	S
Electric moulder spindle tilt 90°-45°	-	-	-	-	-	-	S
2 Axis control for spindle height and tilt	-	-	-	-	-	-	O
Overhead control panel for Digi Drive	-	-	-	-	-	-	O
Moulder spindle Ø 30 mm, usable height 140 mm	-	-	-	-	-	-	S
High speed spindle 16000 rpm	-	-	-	-	-	-	O
Electro magnetic spindle locking	-	-	-	-	-	-	O
Moulder fence 250 for max. tool diameter 250 mm	-	-	-	-	-	-	S
Centrex moulder guard	-	-	-	-	-	-	S
MULTI setting system for moulder fence 250, driven by electric motor, for parallel guidance and quick-setting, with digital read-out	-	-	-	-	-	-	S
Spindle fence plates anodised with "safety bar guides" 550 mm	-	-	-	-	-	-	O
Safety fence plates "Integral"	-	-	-	-	-	-	O
Control Systems							
LED display on the operating panel for sawblade height, angle and sawblade speed	S	S	O	-	-	-	-
Automatic rip fence adjustment when tilting the sawblade	S	-	-	-	-	-	-
CNC-positioning for drive mechanism, sawblade height/tilt	S	O	-	-	-	-	-
Overhead control panel with cutting width 1000/1250 mm	O	O	-	-	-	-	-
Overhead control panel with cutting width 1600 mm	O	O	-	-	-	-	-
Sliding Tables anodized							
Sliding table, cutting length 2050 mm	-	-	W	-	-	-	-
Sliding table, cutting length 2200 mm	W	W	-	-	-	-	-
Sliding table, cutting length 2500 mm	-	-	S	-	-	-	-
Sliding table, cutting length 2800 mm	S	S	O	-	-	-	-
Sliding table, cutting length 3200 mm, 3700 mm	O	O	O	-	-	-	-
Remote ON-switch on sliding table	O	O	O	-	-	-	-
Tenoning and slotting Tables, "X-Roll" guidance system							
Tenoning and slotting table, anodised, 1300 mm	-	-	-	-	-	-	S
Anodised 2050 mm tenoning and slotting table	-	-	-	-	-	-	O
Outrigger Tables and Crosscut Fences							
Outrigger table 1100	-	-	-	-	-	-	O
Outrigger table with work-piece roller, Miter-scale for the cross-cut fence	S	S	S	-	-	-	-
Outrigger table telescopic frame with workpiece roller 1750 x 650 mm	O	O	-	-	-	-	-
Precision mitre guide for outrigger table, cutting length compensation when tilted	O	O	O	-	-	-	-
1100 mm cross-cut fence	-	-	-	-	-	-	O
Cross-cut fence 3200 mm, tilting from 90°-45° with 2 standard crosscut stops	S	S	S	-	-	-	-
Cross-cut fence 3200 mm, tilting from 90°-45° with 2 digital fence stops	O	O	-	-	-	-	-
Cross-cut fence 3200 mm, tilting from 90°-45°, up to 1900 mm with 1 digital fence stop and 1 standard telescopic fence stop up to 3200 mm	O	O	-	-	-	-	-
Digital cross cut stop 1900 mm, 1 digital fence stop, extendable to 3200 mm for outrigger 1300/1500	-	-	O	-	-	-	-
Digital cross cut stop 3200 mm, 2 digital fence stop, for outrigger 1300/1500	-	-	O	-	-	-	-
General							
Dust extraction outlet, Ø in mm	120/100	120/100	120/80	140	140	140	140 + 80
Weight, kg (with average equipment)	1200	1200	885	900	700	650	650

S Standard equipment, W Optional equipment at no extra cost, O Additional extras, PA Price on request; * Power rating S6/40 %, ** Cutting length with outrigger at max. cutting height

FORMAT

- All round supplier for trade and industry!
Our philosophy: "Everything out of one hand"!

finish 1100/1300



finish 1100, finish 1300
The only choice when you are looking for a more than perfect finish on your workpiece!

Beneath a layer of perfectly varnished, waxed or oiled wood surface is always a perfectly sanded surface. Format-4 differentiate themselves based on their solid construction, ground breaking technology and optimal productivity.

At Format-4 the choice is yours: 1100 mm or 1300 mm workable width, various sanding modules and much more. The expected Format-4 quality, the precision and the user friendliness, remain present.

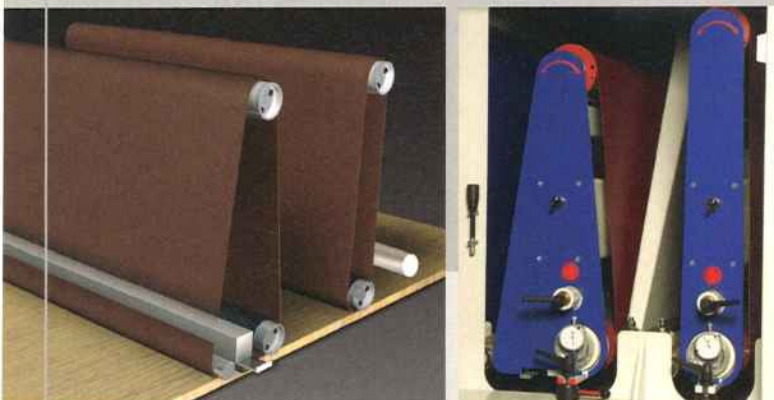

perfect from FORMAT-4
Perfect performance, when dealing with corners!

providing you with the highest precision, fast conversion times and extreme flexibility combined with the best possible price performance ratio, the perfect Format 4 edgeworking machines!

Nowhere are the areas of variable deployment scenarios and demands so large than with the edgeworking machine.

The Format-4 offers you a wide variety of different size and performance levels, ranging from a simple melted glue pot up until the „premium class“ with joint and edge rounding system!

1 4 5 6 7 8



perfect 2, small but extremely capable at an outstanding price:

The spaceage wonder for coiled edging material up to 3 mm in thickness. The workpiece is transported via a chain feeder past a guillotine, two sawing modules and highly durable radius spindles. When it comes down to performance and accuracy, even the "small" belongs to the greats.

perfect

10 models
in every
performance and
price range

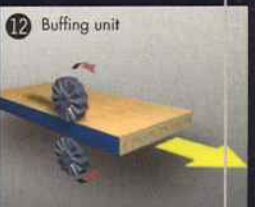
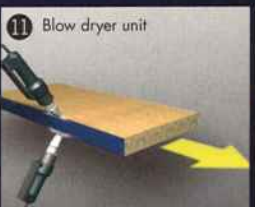
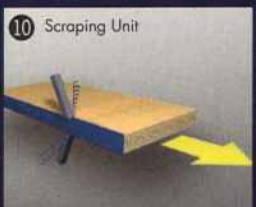
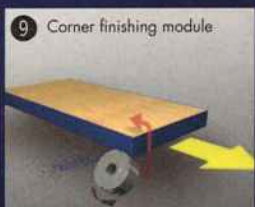
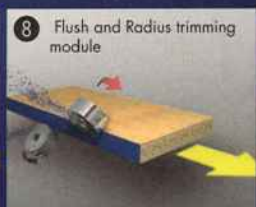
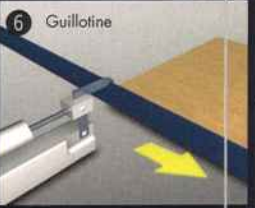
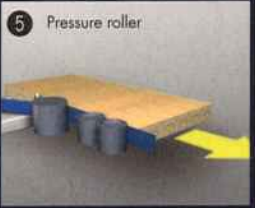
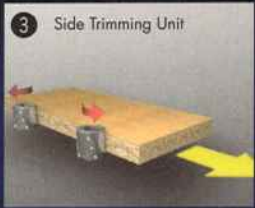
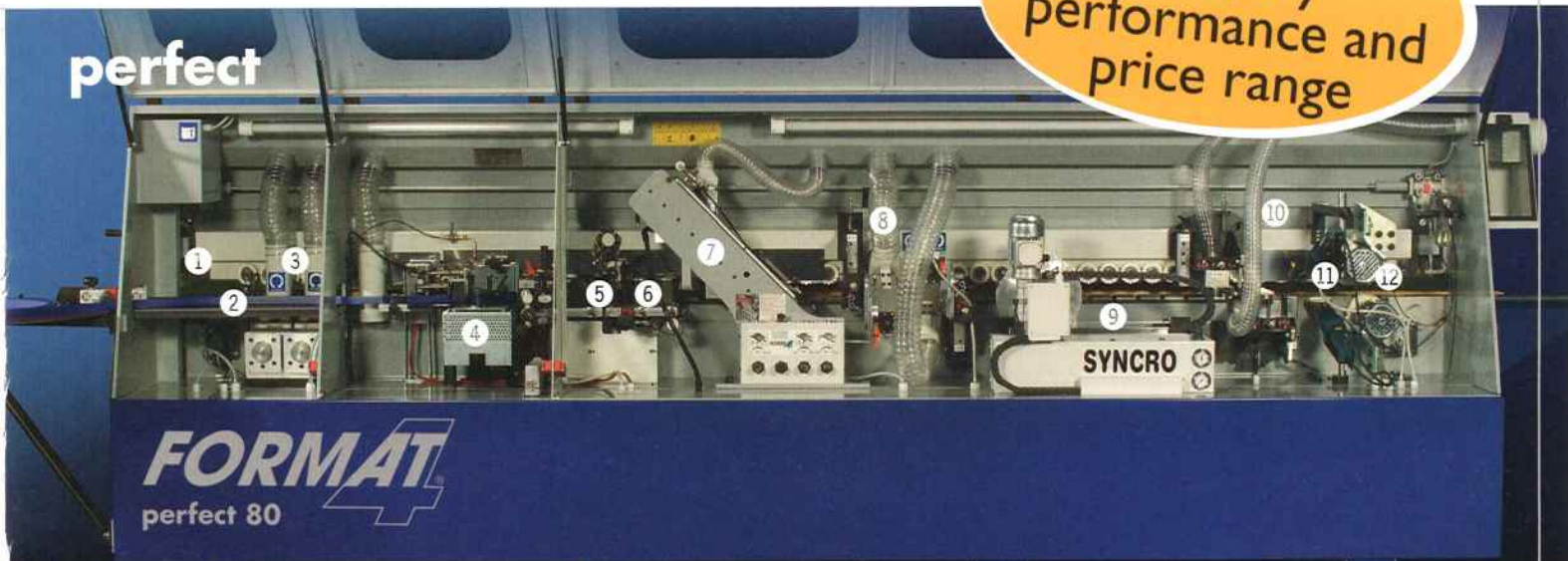

1 2 4 5 6 7 8



perfect 10, "high standard" at the best possible price to performance ratio:

Small footprint, robust and durable construction and extremely userfriendly! If you are using coiled edgebanding material and solid wood strip material up to 8 mm, the perfect 10 is the ideal machine for you.

1 2 4 5 6 7 8 10 11 12



perfect 50, for those searching for the perfect middle ground

Highly flexible as well as very quick calibration and setup times. The ideal edgebanding machine for coiled and strip edging material. Polishing, buffing and guillotine units come as standard on the perfect 50. Optional extras are available for even more user comfort.



They provide the means to create a huge variation of work-pieces in no time at all

profit 2, profit 3 – The Profit Making Centres
Reliability, flexibility and precision - three crucial criteria which should not be compromised in your production process.

Profitable, versatile, precise – CNC-centres for every workshop.
Profitability, versatility and precision - three key fundamentals to the future of your business.
With "profit 2" or "profit 3", the Format-4 CNC-machining centres, you are able to produce a huge range and variety of workpiece forms and shapes in the shortest possible time.

In just one clamping position you can carry out all of your required (moulding), drilling and cutting work with the utmost precision in no more than a third of the normal time required.

With the Format-4 "profit 3" self explaining windows software, the task of programming jobs is made easy. With this the convenience of CAD function and 3D views allow you to see the finished workpiece, offering you the chance to show your customers exactly what they will be getting.



profit 2, profit 3

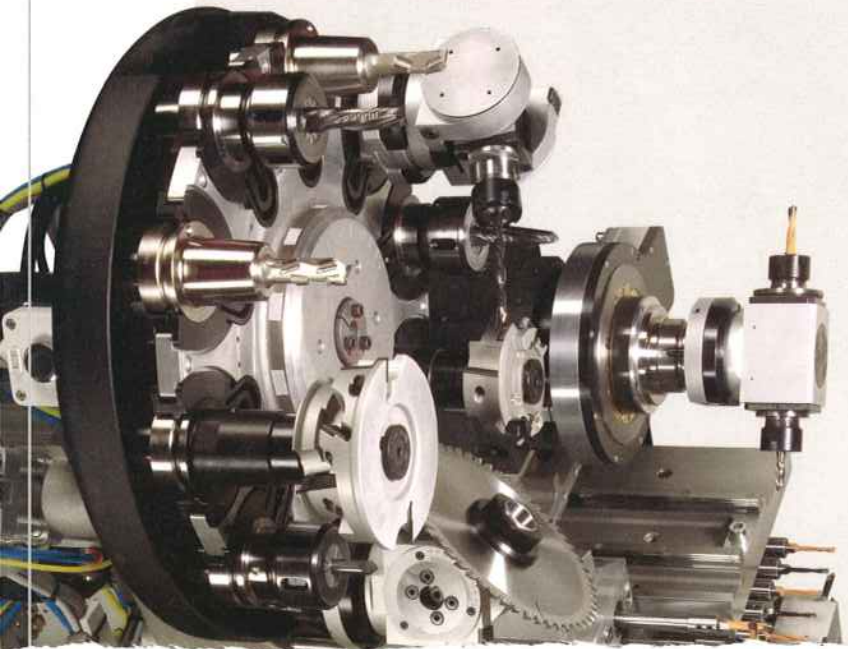
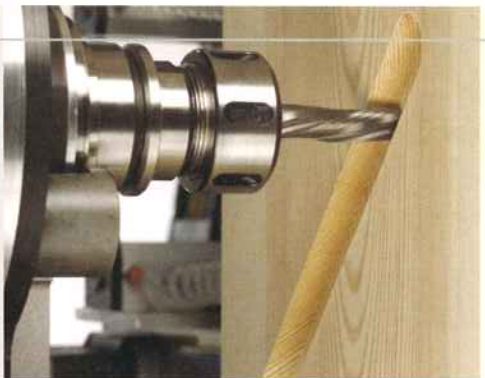

FELDER 900 Series - For small business to large industry!

SERIE 9000

K 975 Professional

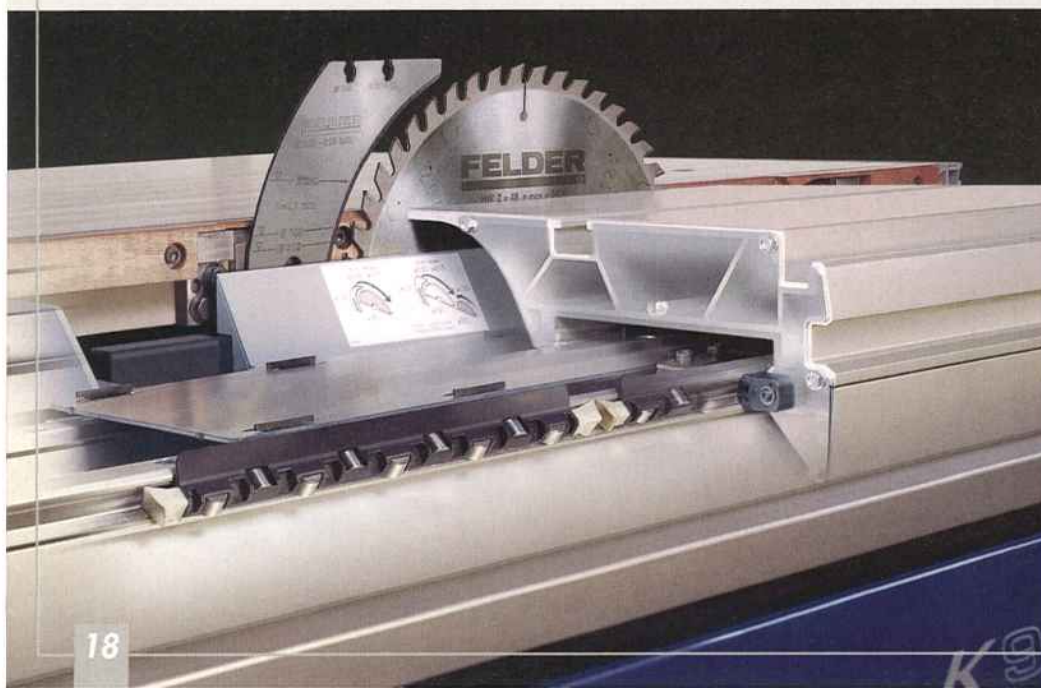

K 915 Professional

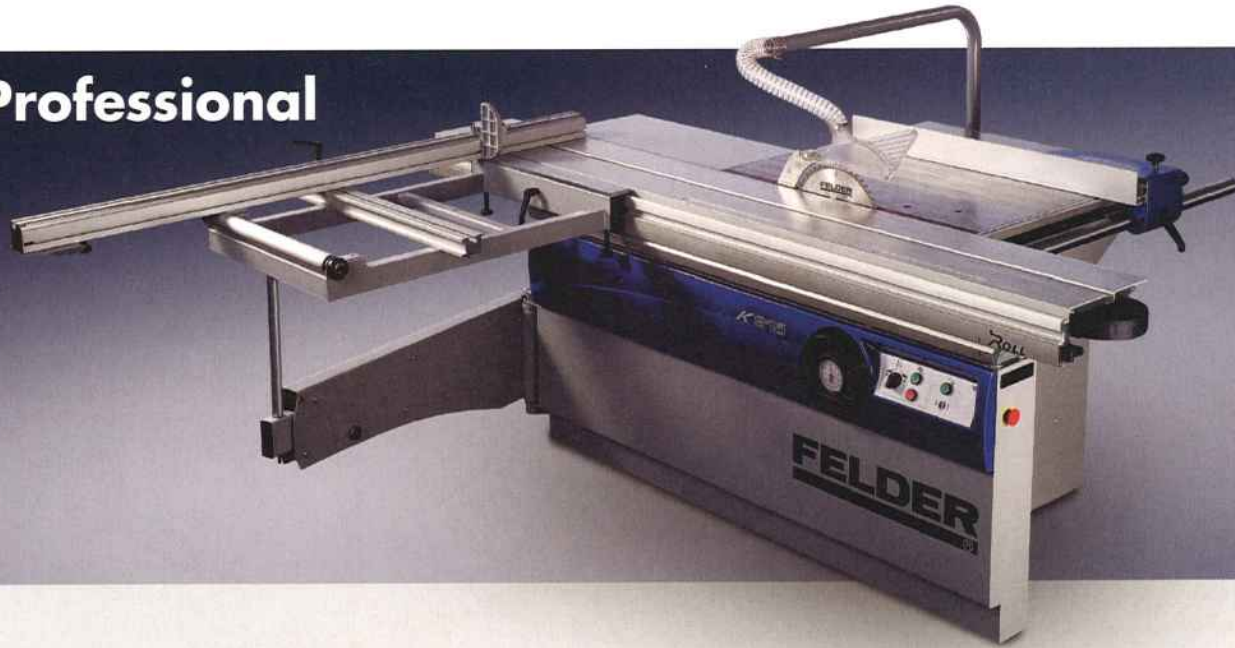

**900 Series sliding table saw - built for one purpose only:
To provide the woodworker with a sensational sawing result**

The 900 series sliding table saw range was developed to provide professional woodworkers with the latest benefits in woodworking machine technology; improvements in precision, user comfort and durability.

Industry expectations for the repeatability of accurate settings, reliability and innovative user friendly features have not just been met with „Serie 900“ but exceeded in each category.

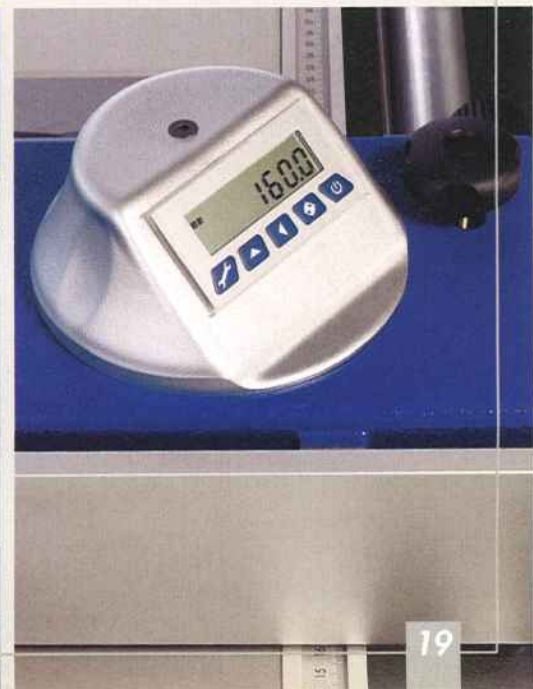

FELDER The solo - machines of the Serie 900 -
precision, reliability and lifespan

A 951



A high quality surface planer with an excellent price - performance ratio!

Even with the solid, heavy planer table the footprint of the A 951 is kept to a minimum thanks to the perfectly integrated heavy planer fence. The 4- or 6- knife cutterblock with self aligning planer knives and quick adjustment of depth of cut lends this machine its unique character, making it stand out from the rest.

AD 951



Are you looking for a Planer-Thicknesser with massive cast iron tables, 4 column thickness table guidance, highly advanced cutterblock system and maximum operating convenience?

Then the Felder AD 951 is the right machine for you.

The patented, planer table adjustment system gives this machine true class.

With a 120 mm diameter, 4 or 6-knife cutterblock and the unique planer knife changing system, Felder offers you the AD 951 for top of the range performance and user comfort.

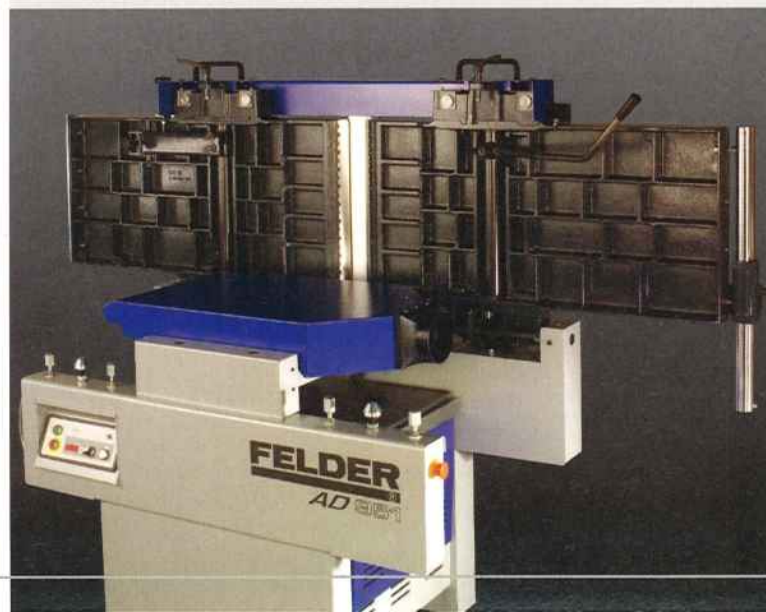
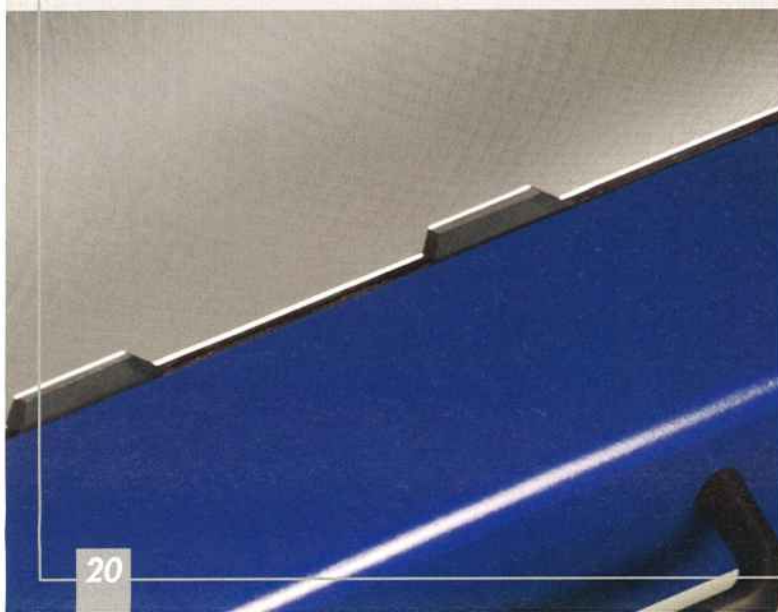

F 900

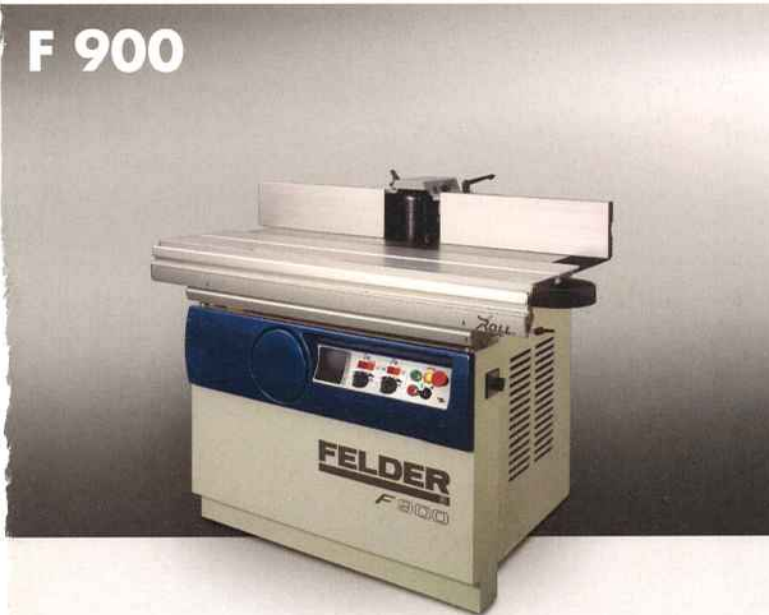

For premier class results in craft work and industry - the F 900 tilting spindle moulder with quick-change spindle system

900 Series machines excel through their sheer elegance and high level of stability. Inside this robust machine conception is the highest level of machining precision.

Designed especially for use in large industries, its spindle moulder unit runs via a precision double guidance system for the tilting segments to ensure the exact setting of the spindle angle. Height adjustment is carried out via a dovetail guiding system again resulting in a high level of precision.

These features guarantee the highest moulding quality!



D 951



The perfect thicknessing result has only one name - D 951!

These machines will provide you with more precision and quality than you would ever imagine from a thickness planer.

Technological advancements have taken the Felder planing results to a new dimension with features such as the exact thickness table adjustment, the thickness table extension system, the 120 mm diameter 4 or 6 knife cutterblock configuration and the unique quick change knife system combine to create the perfect thicknesser!

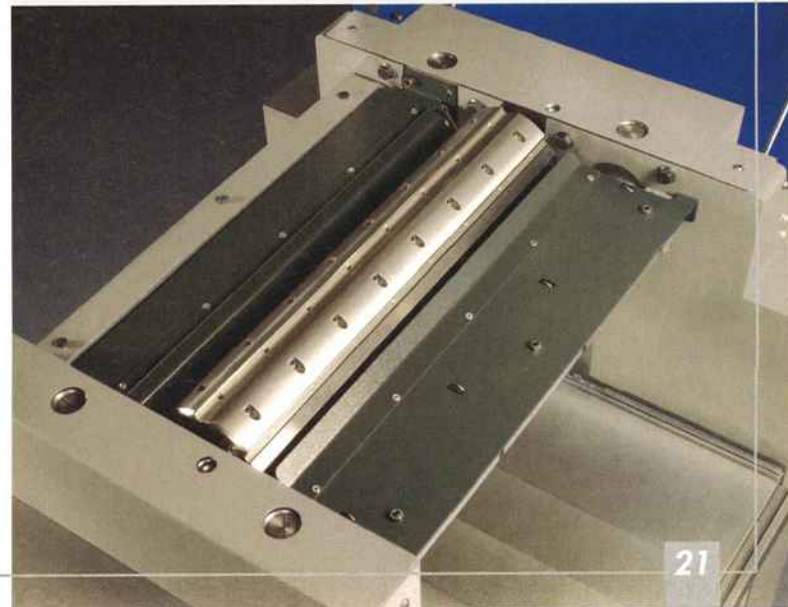

Technical data FELDER-Serie 900

	K 975 Professional	K 915 Professional	A 951	AD 951 Power-Drive	F 900 Power-Drive	D 951 Power-Drive
Electrics						
3x 400 V motor voltage	S	S	S	S	S	S
Variable speed control of all units with soft-start (instead of star-delta start), only for 7.5 HP (5.5 kW)	○	○	-	-	-	-
Variable speed control 1500–11000 rpm with soft-start for 3x 400 V or 3x 230 V, only with 10.0 HP (7.35 kW), (instead of star-delta start)	-	-	-	-	○	-
Electronic speed display	S	-	-	-	-	-
50 Hz motor frequency	S	S	S	S	S	S
Motor power 5.5 HP (4.0 kW)*	S	S	S	S	-	S
Motor power 7.5 HP (5.5 kW)*	○	○	○	○	S	○
Motor power 10.0 HP (7.35 kW)*	○	○	○	○	○	○
Motor power 13.5 HP (10.0 kW)*	-	-	○	○	○	○
Star-delta start, required for 7.5 HP and upwards	○	○	○	○	S	○
Forward and Reverse Run	-	-	-	-	S	-
Internal light	○	-	-	-	○	-
Potential free contact	○	○	○	○	○	○
Operating hour counter	○	○	○	○	○	○
3 phase EURO-plug with delayed start for extractor or power feeder	-	-	-	-	○	-
Cable connections to disconnect switch board or separate machine	-	-	○	○	-	-
Surface Planer and Cutterblock						
Surface planing width in mm	-	-	510	510	-	-
Planer table length in mm	-	-	2250	2250	-	-
Surface planer fence 1150 mm	-	-	S	S	-	-
4 knife Felder-system cutterblock	-	-	S	S	-	S
4 knife standard cutterblock	-	-	○	○	-	○
6 knife Felder-system cutterblock (minimum motor power 10.0 HP (7.35 kW))	-	-	○	○	-	○
4 knife TERSA-system cutterblock	-	-	○	○	-	○
Thickener and Feed Drive						
Thickness planing width in mm	-	-	-	504	-	504
Thickening table length in mm	-	-	-	900	-	900
Electric thickener table height control (Power Drive D1)	-	-	-	S	-	S
LED Display for thickening table adjustment for Power-Drive D1	-	-	-	S	-	S
Position Control for thickening table height Digi-Drive D1 with pre-setting of dimensions	-	-	-	○	-	○
Adjustable rollers below the thickening table, adjustment range 0–0.5 mm	-	-	-	○	-	○
Rubber infeed and outfeed roller	-	-	-	○	-	○
Sectional pressure bar at infeed side	-	-	-	○	-	○
Variable speed drive 4–16 m/min "Vario"	-	-	-	S	-	S
Saw and Scoring Unit						
Max. cutting height 104 mm, 1 speed (4800 rpm)	-	S	-	-	-	-
Max. cutting height 133 mm, 3 speeds (3500/4500/5500 rpm)	S	-	-	-	-	-
Removable flange for slotting tools incl. a set of flanges	○	○	-	-	-	-
Manual saw blade tilt and display by digital clock	S	S	-	-	-	-
Electrical tilt adjustment	○	○	-	-	-	-
LED-display for height	○	○	-	-	-	-
LED-display for tilt and height	○	○	-	-	-	-
2 Axis control for spindle height and tilt	○	○	-	-	-	-
Rip fence with fine adjustment	S	S	-	-	-	-
Rip capacity 800 mm	S	S	-	-	-	-
Rip capacity 1250 mm	○	○	-	-	-	-

	K 975 Professional	K 915 Professional	A 951	AD 951 Power-Drive	F 900 Power-Drive	D 951 Power-Drive
Electronic digital display for rip capacity 800 mm	○	○	-	-	-	-
Electronic digital display for rip capacity 1250 mm	○	○	-	-	-	-
Extractor pipe mounting for rip capacity 800/1250 mm	-	○	-	-	-	-
Saw guard EURO II	-	S	-	-	-	-
Overhead saw guard	S	○	-	-	-	-
Scoring unit "Classic" 1.1 kW, (1.5 HP) scorer adjustable vertically and laterally	○	○	-	-	-	-
Electrical height adjustment with automatic rise and fall when connecting/ disconnecting	○	○	-	-	-	-
Spindle Moulder Unit and Spindle Fence						
Electrical height adjustment for the moulding spindle	-	-	-	-	S	-
Electric moulder spindle tilt 90°-45°	-	-	-	-	S	-
LED-display for spindle height and tilt	-	-	-	-	S	-
2 Axis control for spindle height and tilt	-	-	-	-	○	-
Moulder spindle Ø 30 mm, positioning range 140 mm	-	-	-	-	S	-
High speed router spindle 16.000 rpm, instead of Ø 30 mm spindle	-	-	-	-	○	-
Spindle locking	-	-	-	-	○	-
Spindle fence 240 for max. tooling diameter 230 mm	-	-	-	-	S	-
EURO - Spindle moulder guard	-	-	-	-	S	-
MULTI adjustment for spindle fence 240 enabling parallel running and quick setup	-	-	-	-	S	-
Aluminum spindle fence plates anodised 550 mm	-	-	-	-	○	-
Spindle fence plates anodised with "safety bar guides" 550 mm	-	-	-	-	○	-
Safety fence plates "Integral" 500 mm	-	-	-	-	○	-
Tenoning hood (tooling dia. max. 350 mm) with speed regulation	-	-	-	-	○	-
Sliding Tables						
Dimension sliding table L, cutting length 2050 mm**	○	-	-	-	-	-
Dimension sliding table F, cutting length 2500 mm**	S	S	-	-	-	-
Dimension sliding table X, cutting length 2800 mm**	○	○	-	-	-	-
Dimension sliding table XL, cutting length 3200 mm**	○	○	-	-	-	-
Dimension sliding table XXL, cutting length 3700 mm**	○	○	-	-	-	-
Dimension sliding table anodised	S	S	-	-	-	-
Tenoning and slotting Tables, "X-Roll" guidance system 1200 mm, anodised	-	-	-	-	S	-
Tenoning and slotting Tables, "X-Roll" guidance system 2000 mm, anodised	-	-	-	-	○	-
Remote ON-switch on sliding table	○	○	-	-	-	-
Outrigger Tables and Crosscut Fences						
Outrigger table 1100	-	-	-	-	○	-
Outrigger Table 1300	S	S	-	-	-	-
Outrigger Table 1500 for cutting length from 2800 mm	W	W	-	-	-	-
Crosscut fence 1100 mm for all sliding tables	○	○	-	-	○	-
Telescopic extension for crosscut fence 1100 mm to 2000 mm	○	○	-	-	○	-
2600 mm crosscut fence for outrigger table	-	-	-	-	○	-
Crosscut fence 3200 mm for outrigger table with 2 crosscut stops instead of crosscut fence 2600 mm	○	○	-	-	-	-
Precision mitre unit with pin locating system for outrigger table crosscut fence	○	○	-	-	-	-
Digital crosscut fence 1900 mm, with telescopic extension 3200 mm for outrigger 1300/1500 (not available with precision mitre unit)	○	○	-	-	-	-
Digital crosscut fence 3200 mm for outrigger 1300/1500 (not available with mitre index system)	○	○	-	-	-	-

S Standard equipment, W Optional equipment at no extra cost, ○ Additional extras, PA Price on request; * Power rating S6/40 %, ** Cutting length with outrigger at max. cutting height

FELDER Latest additions to the
FELDER 900 Series program

FW 1100



The FELDER Wide Belt Sanding Machine 950 or 1100 for perfect surfaces!

The new Wide Belt Sanding Machines with 950 or 1100 mm working width, complete the Felder series 900 production range for craftsmen and small businesses. At your instruction, the calibration and fine sander combination module with contact roller and sanding shoe, or segmented, scattered sanding shoe is available.

Wide Belt Sanding Machines are equipt with contact rubber rollers and an electronic pneumatic sanding shoe or a segmented sanding shoe!

FD 921



FD 921 – the wallplug drill has never been more accurate!

The FD 921 is equipped with 21 spindles and is suitable for drilling dowel bores, hinge bores and line boring of up to 35 mm drill diameter. The chucks are placed in a 32 mm grid.

A heavy duty solid cast iron table, side fences, pneumatic hold-downs and ergonomical, userfriendly control elements ensure the FD 921 is in a class of its own.

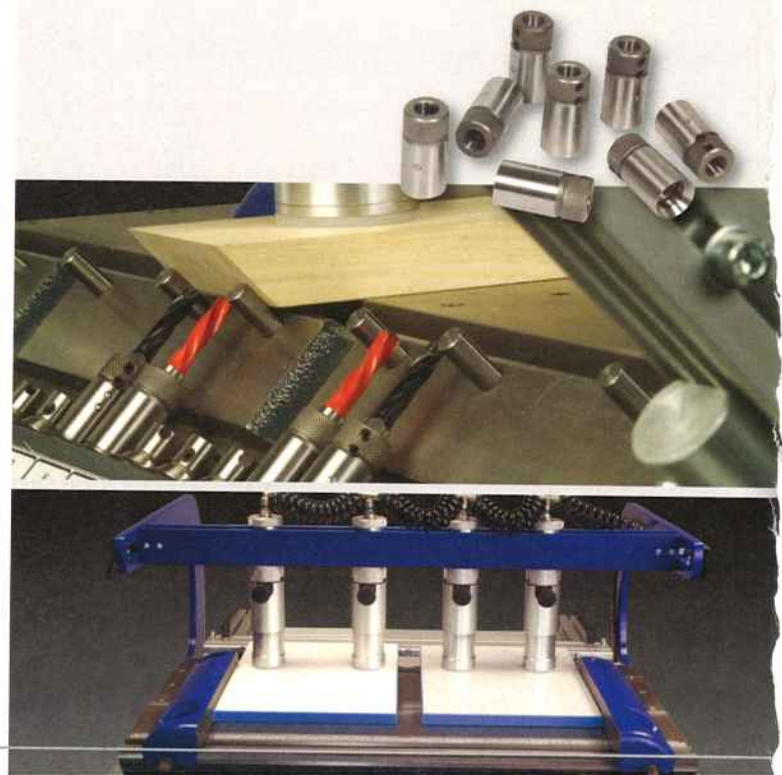

P 200

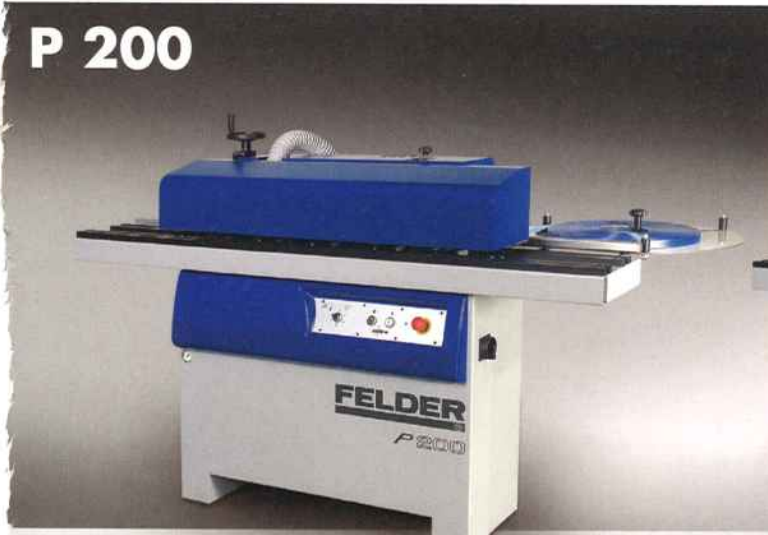

**Looking to work with pre-glued edges?
With the P 200 you don't need to make any
more compromises!**

For an extremely fair price we guarantee quality, performance and precision just as you would expect!

The P 100 edgebander for pre-glued edges (tape thickness 0,4–1,2 mm) and P 200 (tape thickness 0,4–2,0 mm) stand out straight away due to their robust and compact build, minimum space requirement and a very well thought through machine concept.

The highlights of this machine are the short setup time, an extremely short warm up period and quick adjustment of the workpiece and edging material size.

G 200/G 300



**Looking to glue your own edges?
Then you are absolutely spot on with the G 200/
G 300 edgebander for standard edges.**

wood and plastic edges up to 3,0 mm*, exact adjustments for panels between 10–45 mm, solid top and bottom shaper cutters for 90° above and below trimming and a combination spindle moulder unit for perfect moulding results, all come as standard on the G 200/G 300!

* 2,0 mm – G 200
3,0 mm – G 300

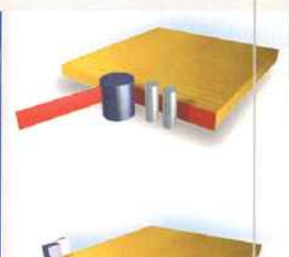
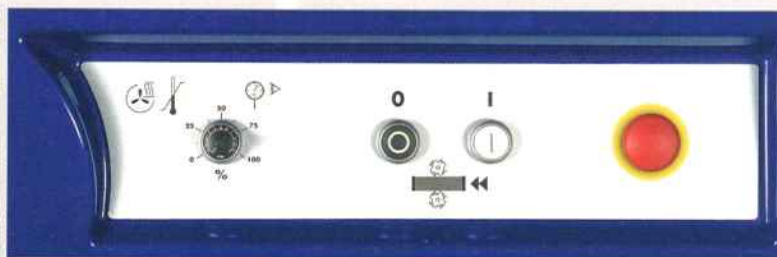

FELDER Serie 700 - the range for the
woodworking professional

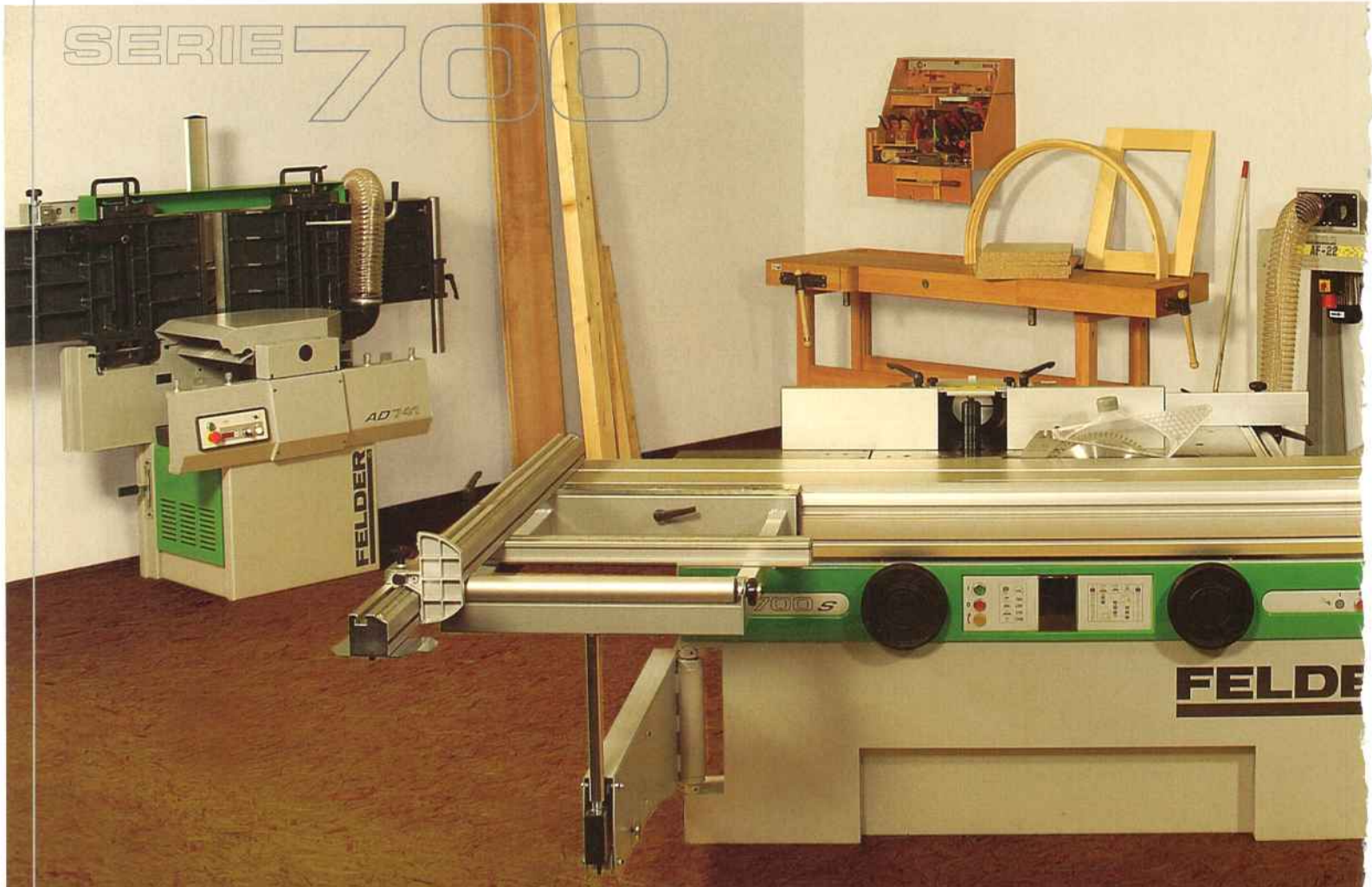



Every carpenter's dream

For decades woodworking professionals have enjoyed a great partnership with Felder. Our comprehensive selection of full combination machines, part combination machines, solo machines and a first class accessory and tooling program make Felder a „first-choice“ supplier for all woodworking professionals.

After working with a Felder for only a few minutes you will be impressed. The simple function of the format sliding table, the easily controlled circular saw or the spindle moulder unit, the easy to read scales, ...

A felder never lets you down!

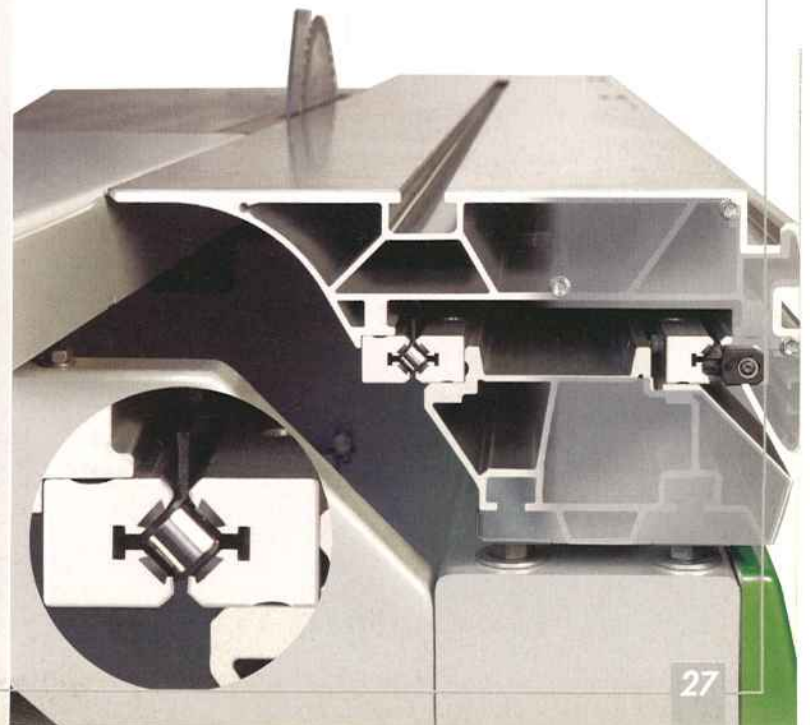

FELDER®

For the last 50 years it has been our goal to construct the very best woodworking machinery

CF 741



Size, performance, precision and versatility in one unit. – CF 741

A top machine that you can have fun with for years ...

The shortest change over time combined with maximum performance. Perfect user friendliness and many more components all combined, make this machine stand out from all the rest!

Main machine components are constructed from cast iron, electronically balanced spindles as well as the use of high tech linear-bearing guiding systems provide the smooth operation and precision of the CF 741 Woodworking Systems.



KF 700 S Professional



Newly defined ... KF 700 S Professional

It is our company's philosophy to produce performance orientated, reliable machines to the highest technical standards. The KF 700 combines a maximum of performance, precision and versatility. Without doubt, optimum operating convenience and quickest change over times were number one priorities for our design team.

Characteristics such as the industrial outrigger table with large supporting surfaces and cutting lengths of up to 3200 mm or the parallel cutting fence with quick and fine adjustment, make this saw spindle moulder something special

Upon request we can provide your KF 700 S Professional with electrical spindle height adjustment.



AD 741



AD 741 – Top quality - without compromising

A good machine is a machine that has been thought through.

As by all good things, the difference lies in the detail the thicknesser table that is guided by 4 spindles, the precise thicknesser table height adjustment with a hand wheel with digital display, the electrical or optionally with the positioning control, the professional jointing fence and 2000 mm table length surface planer with the Felder table extension system of upto 3000 mm extendable, all the components a planer thicknesser machine should have.

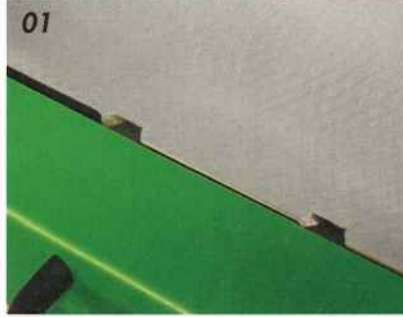

01

01 Accurate and quick adjustment of cutting depth from the operator side of the infeed table.

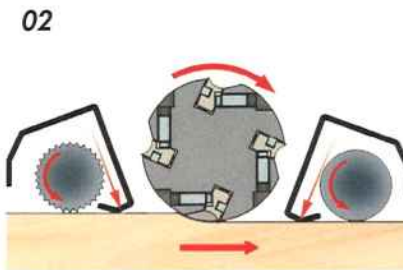

02

02 All our surface-thickness-planers are equipped with a spring loaded in-feed pressure bar. It avoids vibration of the work piece during thicknessing.

03 Saw blade angle adjustment from 90°–45°.

04 All Felder spindle moulders tilt 90°–45° as standard.

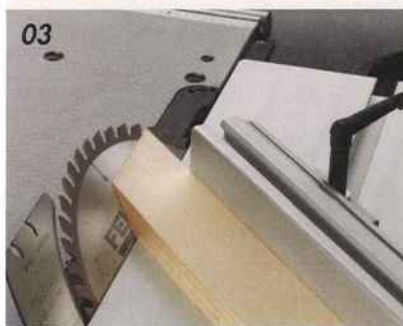

03

As with all good things, the difference lies in the details. The thicknesser table is guided on 4 spindles, the precise thicknesser table height adjustment is carried out through a hand wheel with digital display, the professional jointing fence and 2000 mm table on the surface planer with the option of using Felder table extensions of up to 1000 mm combine to offer all the functions a planer thicknesser should have and more.



04

05 Settings with an accuracy to a tenth of a millimetre can be obtained using the electronic digital display incorporated in the parallel cutting fence.



05

06 A 6 year guarantee for the Felder linear guiding system on the panel sliding table! The sliding table profile is based on closed 6-chamber technology. This design assures long lasting accuracy with the panel sliding table even under heavy loads and resists torsion induced twisting or bending.



06

FELDER®

Serie 700 - for the professional and everyday woodworker

K 700

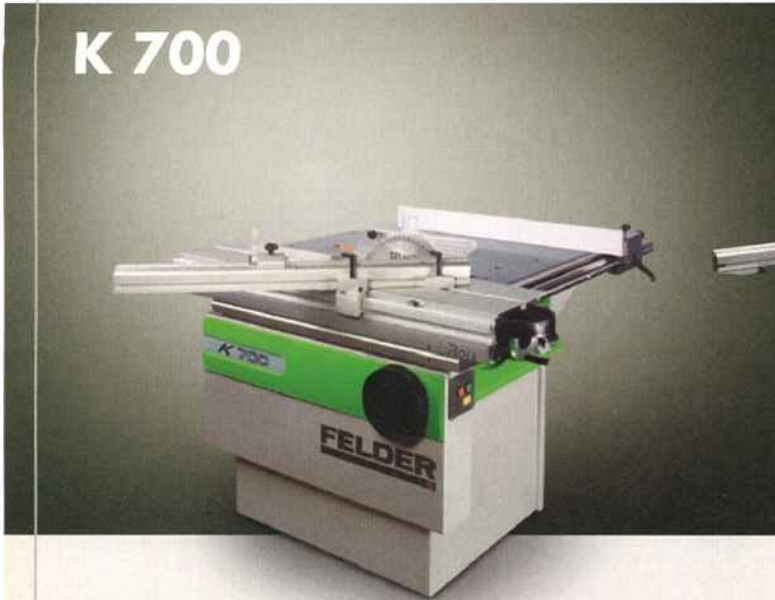

FELDER is always aiming to give the woodworker the most sensational saw results!

The K 700 offers technological solutions which are unique.

Intelligent innovations like the circular saw unit with the precision double guiding system for the exact setting of the saw blade angle with zero play and dovetail restricted guiding system for exact aligned height adjustment, awards this machine its unmistakable uniqueness.

The sliding table with double mitre fence, the exact programming and reading possibilities of the cutting fence and the parallel cutting fence with the fine adjustment, these are only a few of the details that are very convincing!

K 700 S Plus



The top seller from the FELDER circular saws – K 700 S Plus

One of the best circular saws on the market, but we will not rest at that - we develop further!

Convincing details such as smooth running, absolute precision and extremely hard wearing, can only be expected from Felder.

The lifetime of a panel saw is measured above all by how long the sliding table functions faultlessly and precisely. We are so sure of the durability the Felder sliding table „X-Roll“ that we offer a 6-year warranty on its proper functionality.

Other impressive details, such as the outrigger table with the double mitre fence, the exact positioning and readability of the cutting fence and the parallel cutting fence with speed and fine adjustments, will impress you.

The Felder K 700 S Plus wins you over because it has outstanding details, dynamic design, and is absolutely reliable!

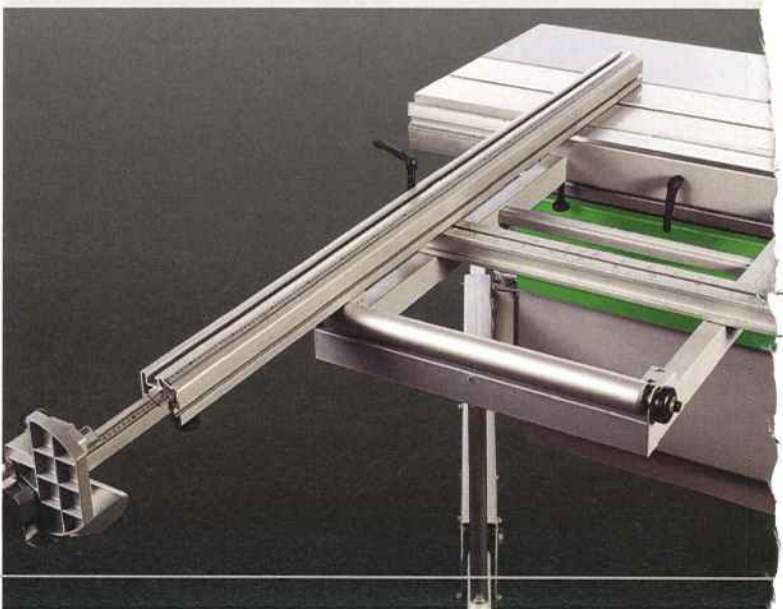

F 700 Z



A winning combination - the F 700 Z tilting spindle moulder machine with slot and tenon table

The classical spindle moulder for moulding, slot and tenoning work.

The professional moulder fence with optimally formed chip channel, the sub-table chip extraction system, the moulding spindle quick-change system as well as the slot and tenoning table are just a few of the standard features that guarantee the machine's high level of performance and precision.

An absolute highlight for professionals: the optional electrical moulder spindle height adjustment with digital spindle positioning control!

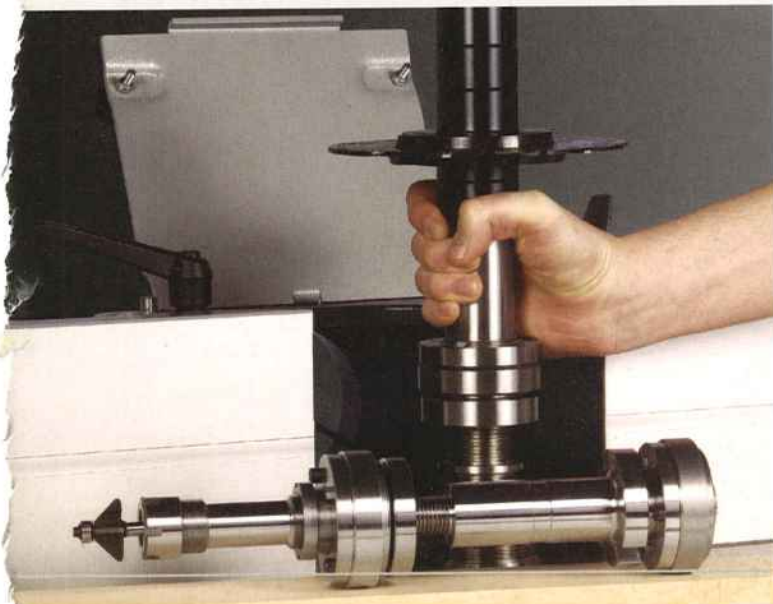

A 741



A 741 – The surface planer with professional components that were thought through in the smallest detail!

A machine with extra class.

Long, solid planer tables made from machined cast iron, comfortable adjustment of the depth of cut, tiltable planing fence and the Felder quick change knife system are the highlights on the A 741.

A combination of modern technology and perfect planing quality, with this machine you can only win!



Technical data FELDER-Serie 700

	CF 741	KF 700 S Professional	AD 741 Power-Drive	K 700	K 700 S Plus	F 700 Z	A 741
Electrics							
3x 400 V motor voltage	S	S	S	S	S	S	S
1x 230 V motor power 4.0 HP (3.0 kW)*	O	O	O	O	O	O	O
1x 230 V, motor power 5.0 HP (3.6 kW)* with variable speed for all main-drives	O	O	O	O	O	O	O
Variable speed control of all units with soft-start (instead of star-delta start), only for 7.5 HP (5.5 kW)	O	O	O	O	O	O	O
Motor power 4.0 HP (3.0 kW)*	S	-	S	S	-	-	S
Motor power 5.5 HP (4.0 kW)*	O	S	O	O	-	S	O
Motor power 7.5 HP (5.5 kW)*	O	O	O	O	S	O	O
Motor power 10.0 HP (7.35 kW)*	O	O	O	O	O	O	O
Forward and Reverse Run	S	S	O	-	-	O	O
Surface Planer and Cutterblock							
Surface planing width in mm	410	-	410	-	-	-	410
Planer table length in mm	1640	-	2000	-	-	-	2000
Surface planer fence 1150 mm	S	-	S	-	-	-	S
2 knife Felder-system cutterblock	S	-	S	-	-	-	S
4 knife Felder-system cutterblock	O	-	O	-	-	-	O
4 knife standard cutterblock	O	-	O	-	-	-	O
3 knife TERSA-system cutterblock	O	-	O	-	-	-	O
Thicknesser and Feed Drive							
Thickness planing width in mm	404	-	404	-	-	-	-
Thicknessing table length in mm	620	-	620	-	-	-	-
Digital handw. for thicknessing height in mm	S	-	-	-	-	-	-
Electric thicknesser table height control (Power Drive D1)	O	-	S	-	-	-	-
2nd spring loaded pressure bar	S	-	S	-	-	-	-
LED Display for thicknessing height Power-Drive D1	O	-	S	-	-	-	-
Position Control for thicknessing height Digi-Drive D1	O	-	O	-	-	-	-
2 speed synchronised feed drive $\delta +12$ m/min	S	-	S	-	-	-	-
Saw and Scoring Unit							
Saw unit with blade tilt 90°-45°, cutting height max. 104 mm	S	S	-	S	S	-	-
Digital indicator on handwheel for saw tilt	O	O	-	O	O	-	-
Micro adjustable rip and planer fence	S	S	-	S	S	-	-
Removeable flange for Dado tooling (0-15,5 mm)	O	O	-	O	O	-	-
Link segment on saw-planer table for rip fence	O	-	-	-	-	-	-
Scoring unit "STANDARD"	O	O	-	O	O	-	-
Scoring unit with removable flange	O	O	-	O	O	-	-
Industrial scoring unit 1.0 HP (0.75 kW), 3 phase, independent height and lateral adjustment	O	O	-	O	O	-	-
Scoring unit 1,0 HP (0,75 kW), 3x 400 V with removable flange	O	O	-	O	O	-	-
Rip capacity 800 mm	-	-	-	S	-	-	-
Rip capacity 800 mm with chassis enlargement	-	S	-	O	S	-	-
Rip capacity 1250 mm with chassis enlargement	-	O	-	O	O	-	-
Electronic digital display for rip capacity 800 mm	-	O	-	O	O	-	-
Electronic digital display for rip capacity 1250 mm	-	O	-	O	O	-	-
extractor hose mounting	-	O	-	O	-	-	-
Saw guard EURO II	S	S	-	S	-	-	-
Overhead saw guard	-	O	-	O	S	-	-

	CF 741	KF 700 S Professional	AD 741 Power-Drive	K 700	K 700 S Plus	F 700 Z	A 741
Spindle Moulder Unit and Spindle Fence							
Spindle moulder tilt 90°-45°	S	S	-	-	-	S	-
Digital indicator on handwheel for spindle tilt	O	O	-	-	-	S	-
Moulder spindle Ø 30 mm, usable height 110 mm	S	S	-	-	-	S	-
High speed router spindle 15.000 rpm, instead of Ø 30 mm spindle	O	O	-	-	-	O	-
Electrical spindle height adjustment with electronic digital height display (Power-Drive F1)	O	O	-	-	-	O	-
Digital display for spindle height (Power-Drive F1)	O	O	-	-	-	O	-
Spindle fence 240 for max. tooling diameter 230 mm	S	S	-	-	-	S	-
EURO – Spindle moulder guard	S	S	-	-	-	S	-
MULTI adjustment for spindle fence 240 enabling parallel running and quick setup	O	S	-	-	-	S	-
Aluminium spindle fence plates	S	-	-	-	-	-	-
Aluminium spindle fence plates anodised	O	S	-	-	-	S	-
Spindle fence plates anodised with "safety bar guides"	O	O	-	-	-	O	-
Sliding Tables							
Dimension sliding table M, cutting length 1300 mm**	S	-	-	S	-	-	-
Dimension sliding table L, cutting length 2050 mm**	O	-	-	O	-	-	-
Dimension sliding table F, cutting length 2500 mm**	-	S	-	-	-	-	-
Dimension sliding table X, cutting length 2800 mm**	-	O	-	-	S	-	-
Dimension sliding table XL, cutting length 3200 mm**	-	O	-	-	O	-	-
Dimension sliding table XXL, cutting length 3700 mm**	-	-	-	-	O	-	-
Dimension sliding table anodised	O	S	-	O	S	S	-
Tenoning table 1000 anodised for F 700 Z	-	-	-	-	-	S	-
Tenoning table 2050 anodised for F 700 Z	-	-	-	-	-	O	-
Remote ON-switch on sliding table	O	O	-	O	O	O	-
Outrigger Tables and Crosscut Fences							
Outrigger table 1100	O	-	-	O	-	O	-
Outrigger Table 1300	O	S	-	O	-	-	-
Outrigger Table 1500 for cutting length from 2800 mm	-	W	-	-	S	-	-
Crosscut fence 1100 mm for all sliding tables	S	O	-	S	O	O	-
Telescopic extension for crosscut fence 1100 mm to 2000 mm	O	O	-	O	O	O	-
2600 mm crosscut fence for outrigger table	O	S	-	O	S	O	-
Crosscut fence 3200 mm for outrigger table with 2 crosscut stops instead of crosscut fence 2600 mm	O	O	-	O	O	O	-
Precision mitre unit with pin locating system for outrigger table crosscut fence	O	O	-	O	O	O	-
Digital crosscut fence 1900 mm, with telescopic extension 3200 mm for outrigger 1300/1500 (not available with precision mitre unit)	O	O	-	O	O	-	-
Digital crosscut fence 3200 mm, with telescopic extension 3200 mm for outrigger 1300/1500 (not available with precision mitre unit)	O	O	-	O	O	-	-
Mortising Unit							
Mortising table	O	-	O	-	-	-	O
Mortising chuck 0-16 mm	O	-	O	-	-	-	O
Transport unit for mortising table	O	-	O	-	-	-	O

S Standard equipment, W Optional equipment at no extra cost, O Additional extras, PA Price on request; * Power rating S6/40 %, ** Cutting length with outrigger at max. cutting height

FELDER 500 Series - Top performance at affordable prices!

SERIE 500

**The new 500 Series:
Top performance at affordable prices!**

**A new chapter in the successful FELDER-
GROUP history.**

The time is right for a new range. A range that can be presented as dynamic, strong and good value for money.

A range, that catches your eye straight away. The 500 series presents 5 models, that make your dreams of wood working sensations and contemporary technical Felder solutions come true.

A breath taking combination of high quality performance, precision and versatility at yesterday's price.

Felder has achieved its reputation through thinking along the lines of the individuals they make the machines for!

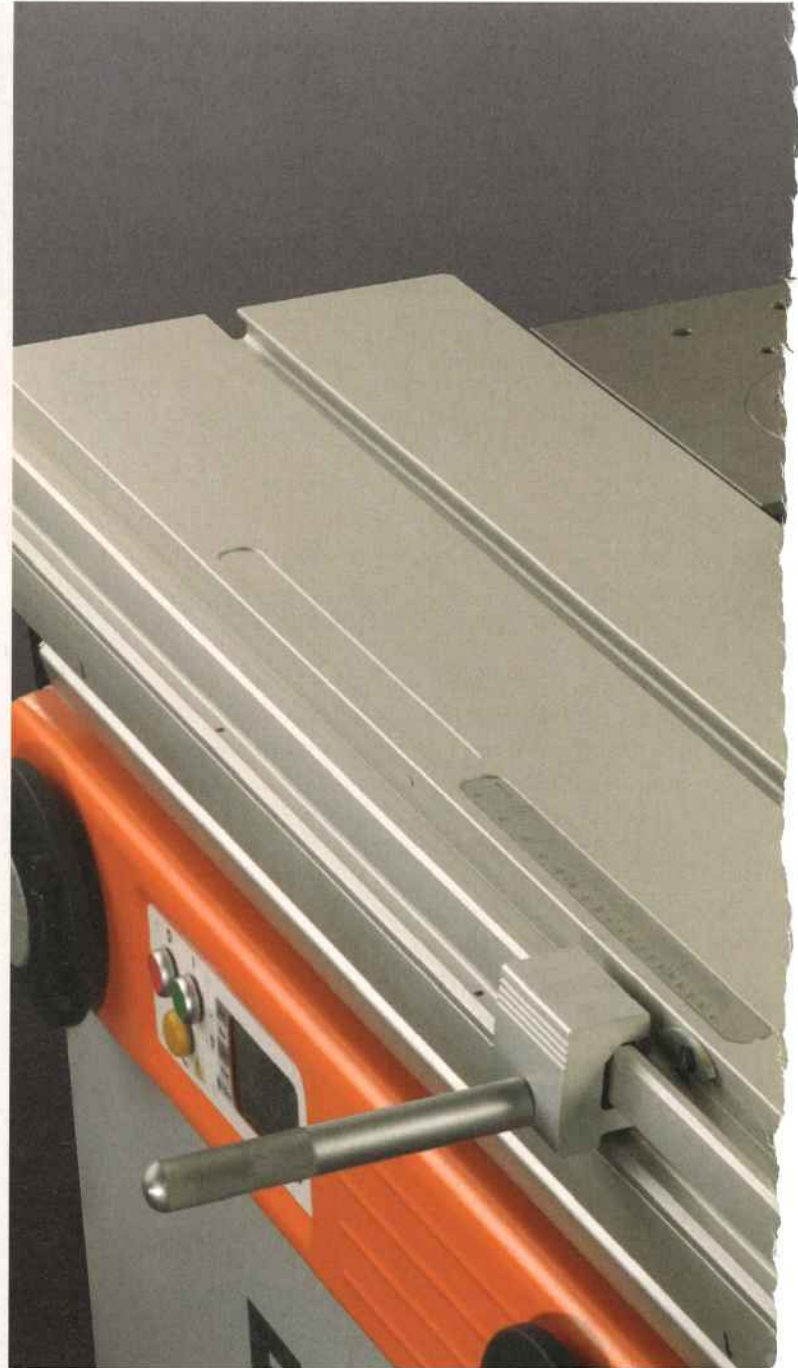

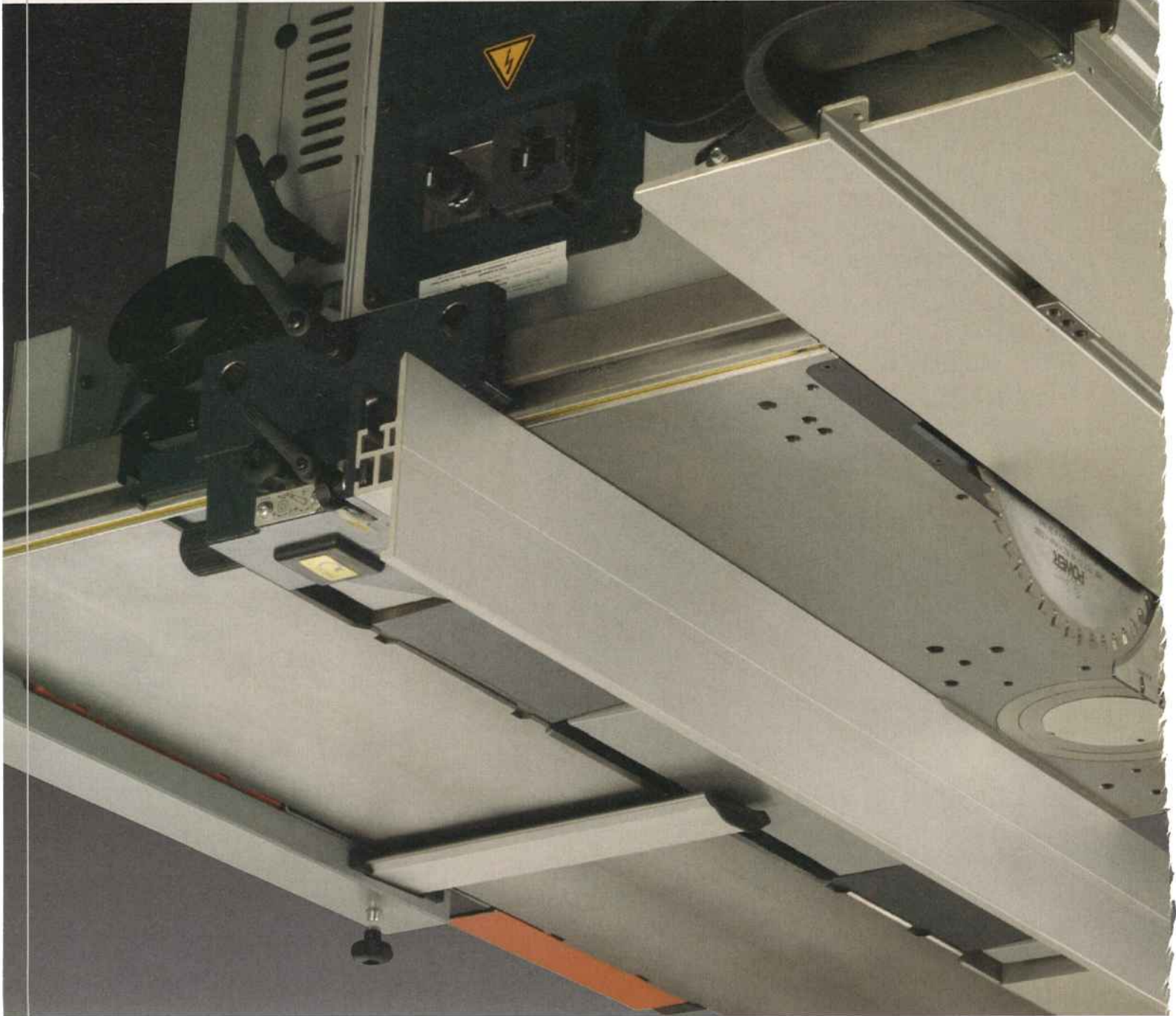
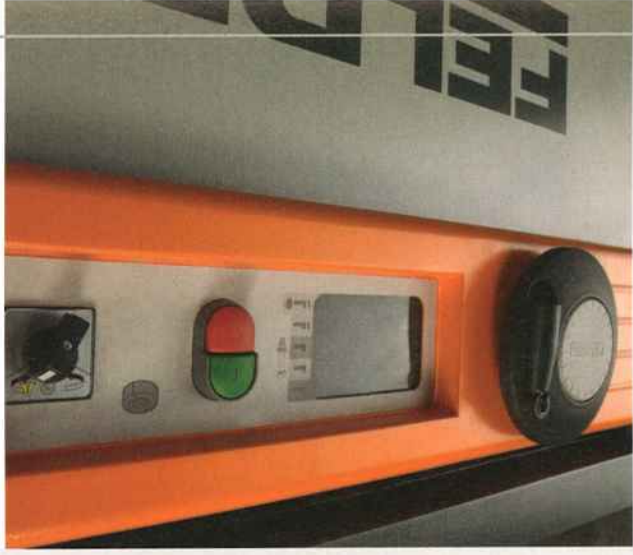

FELDER®

500 Series - Top performance at affordable prices

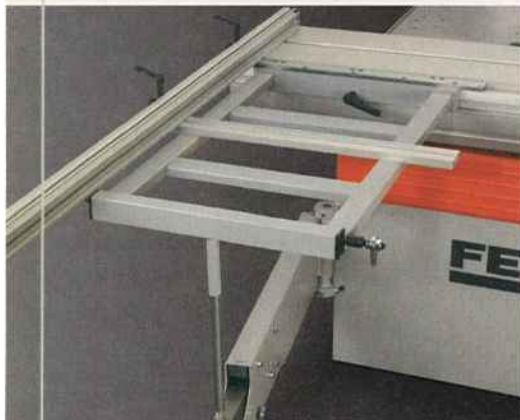
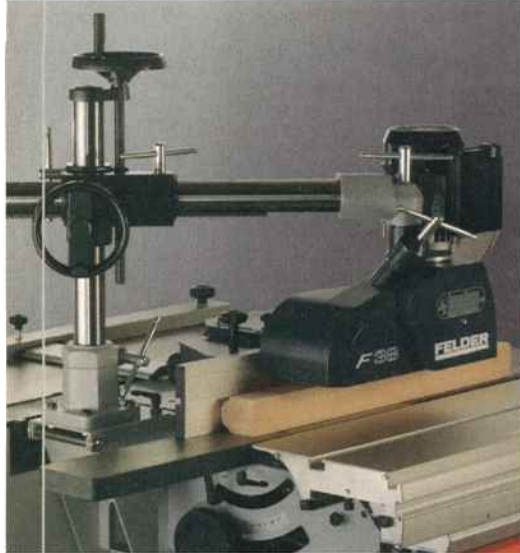

CF 531



Unrivalled value for money – The CF 531

It's amazing how many ingeniously designed components have been packed into this machine – and all for an unbelievably low price. The CF 531 system gives you top machine quality, exceptional performance and unconditional precision while occupying only relatively little space.

Boasting rapid retooling capability and utmost user-friendliness, the CF 531 allows you to easily perform professional planing and thickening, shaping, sizing and, if desired, mortising work.

Planer table length 1500 mm, planing width 310 mm, tiltable table saw 90°–45°, 2- or 4-knife Felder-system cutterblock, moulder fence with high-grade anodised aluminium guides, and the aluminium sliding table with its precision guiding system "X-Roll" – these are just a few of the components that make this machine something really special.

KF 500



Two-in-one – sawing and shaping – KF 500

The saw-spindle moulder KF 500 is exceptional in its price class.

Alongside its favourable price to performance ratio, this machine is amazingly easy to operate and extremely versatile. Thanks to the many functions that have been fused together, it has become a classic in its time!

The highlights of the KF 500 include the aluminium sliding table with „X-Roll“ guiding system, the professional rip fence mounted on a large steel bar as well as the professional package.

F 500

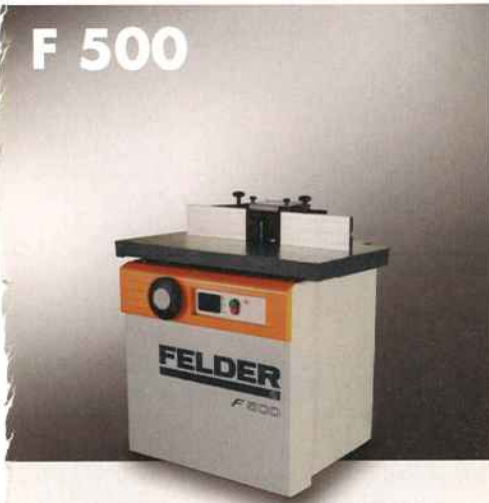

Made to the highest of standards, yet available at the lowest price!

The Felder tilting spindle moulder offers you extraordinary performance and optimal ease of use at a very low price; in other words, this Felder moulder provides quality that is unmatched in this price class!

The F 500 scores points in all disciplines: a moulder fence that measures 220, a moulder spindle that tilts 90°–45° and the capability to switch quickly among the 4 speed settings.

These are features that impress even the most discerning woodworker.

K 500



A saw that is a great value for money, and effortlessly competes with "larger" machines when it comes to performance!

The K 500 embodies true performance and ease of use!

The saw blade tilts from 90°–45°, and is quick and easy to change. Precision is guaranteed with the "X-Roll" sliding table and heavy duty, accurate fences - the rip fence runs on a large steel bar with an integrated fine adjustment feature.

This machine presents a brilliant combination of highly functional components designed for hobby users and small workshops alike.

AD 531



Sophisticated features and details. In this price class it is impossible to find a product that offers better quality for your money!

The AD 531 planer-thicknessener is an integral part of the new Series 500 line-up.

Woodworkers never fail to be amazed when recognizing the combination of exceptional engineering and functional modern design working together in harmony with one another.

The professional planer fence, the robust planer tables made of cast iron, and the 2-knife Felder-system cutterblock (4-knife option) are sure to fascinate every woodworking enthusiast.

Technical data FELDER-Serie 500

	CF 531	KF 500	F 500	K 500	AD 531
Electrics					
3x 400 V motor voltage	S	S	S	S	S
1x 230 V motor voltage	O	O	O	O	O
50 Hz motor frequency	S	S	S	S	S
Motor power 4.0 HP (3.0 kW)*	S	S	S	S	S
Motor power 5.5 HP (4.0 kW)*	O	O	O	O	O
Forward and Reverse Run	S	S	O	-	-
Cable connections to disconnect switch board or separate machine	O	-	-	-	-
Surface Planer and Cutterblock					
Surface planing width in mm	310	-	-	-	310
Planer table length in mm	1500	-	-	-	1500
Length of surface planer fence in mm	1150	-	-	-	1150
Surface planer fence anodised	S	-	-	-	S
Additional table for planer fence	S	-	-	-	S
Planer guard EURO "Standard"	S	-	-	-	S
Planer guard EURO "Comfort"	O	-	-	-	O
2 knife Felder-system cutterblock	S	-	-	-	S
4 knife Felder-system cutterblock	O	-	-	-	O
4 knife standard cutterblock	O	-	-	-	O
3 knife TERSA-system cutterblock	O	-	-	-	O
Thicknesser and Feed Drive					
Thickness planing width in mm	306	-	-	-	306
Thicknessing table length in mm	540	-	-	-	540
Digital handw. for thicknessing height	O	-	-	-	O
Synchronized feeder drive 6 m/min.	S	-	-	-	S
Saw and Scoring Unit					
Saw unit with blade tilt 90°-45°, cutting height max. 102 mm	S	S	-	S	-
Micro adjustable rip and planer fence	S	O	-	O	-
Preparation for Dado tooling up to 15.5 mm width	O	O	-	O	-
Mechanical scoring unit, scoring blade dia. 80 mm	O	O	-	O	-
Rip capacity 800 mm	-	S	-	S	-
Cutting width 800 mm with full table	S	O	-	O	-
Rip capacity 1250 mm	-	O	-	O	-
Digital display for rip fence	-	O	-	O	-

	CF 531	KF 500	F 500	K 500	AD 531
Spindle Moulder Unit and Spindle Fence					
Spindle moulder tilt 90°-45°	S	S	S	-	-
Speed 3000/6000/8000/10,000 rpm	S	S	S	-	-
Table opening	180	180	180	-	-
Moulder spindle dia. 30 mm, usable height 100 mm	S	S	S	-	-
Router spindle 14,000 rpm instead of dia. 30 mm	O	O	O	-	-
Spindle moulder fence 220 for max. tooling diameter 220 mm, Spindle fence plates 350 mm	S	S	S	-	-
Spindle fence 240 for max. tooling diameter 230 mm, Spindle fence plates 450 mm	O	O	O	-	-
EURO – Spindle moulder guard	S	S	S	-	-
Multi-adjustment system for the moulder fence "240"	O	O	O	-	-
Aluminium spindle fence plates anodised	S	S	S	-	-
Spindle fence plates anodised with "safety bar guides"	O	O	O	-	-
Table extension frame for F 500 table	-	-	O	-	-
Sliding Tables					
Dimension sliding table K, cutting length 1000 mm**	S	S	-	S	-
Dimension sliding table M, cutting length 1300 mm**	O	O	-	O	-
Dimension sliding table L, cutting length 2050 mm**	O	O	-	O	-
Dimension sliding table F, cutting length 2500 mm, anodised**	O	-	-	-	-
Dimension sliding table anodised	O	O	-	O	-
Outrigger Tables and Crosscut Fences					
Outrigger table 1100 with telescopic arm (up to cutting length 2050 mm)	O	O	-	O	-
Outrigger table 1300 with telescopic arm (up to cutting length 2500 mm)	O	O	-	O	-
Crosscut fence 1300 mm for all sliding table	S	S	-	S	-
Telescopic extension for crosscut fence 1300 mm to 2050 mm	O	O	-	O	-
2600 mm crosscut fence for outrigger table	O	O	-	O	-
Crosscut fence 2600 mm for outrigger table instead of crosscut fence 1300 mm	O	O	-	O	-
Precision mitre unit with pin locating system for outrigger table crosscut fence	O	O	-	O	-
Mortising Unit					
Mortising chuck, clamping range 0-16 mm	O	-	-	-	O
Mortising table Standard	O	-	-	-	O
Mortising table, heavy professional execution	O	-	-	-	O
Transport unit for mortising table heavy	O	-	-	-	O

S Standard equipment, W Optional equipment at no extra cost, O Additional extras, PA Price on request; * Power rating S6/40 %, ** Cutting length with outrigger at max. cutting height

FELDER® Accessory Machines

Horizontal Mortiser FD 250

- Table size 550 x 300 mm (optional 1550 x 800 mm)
- Mortising motor with roller bearings
- Single hand lever operation
- Drill length 250 mm, Mortising depth 160 mm
- Mortising chuck, suitable for left and right hand cut bits
- Capable of chisel mortising with the mortise chisel tools



Power Feeders Variofeed 3, S-308, F-38, F-48, Variofeed 4

- simple tilting head or an advanced tilting head for every power feeder
- 3 or 4 soft rubber drive rollers
- roller - diameter 100-120 mm, width 50-60 mm



Belt Sanders FS 722

- Sanding table with ball bearings and a table size of 2.200 x 800 mm
- Professional sanding shoe comes standard
- belt drive rollers made out of aluminium
- Sanding belt length 5750 mm, belt width 150 mm
- Extractor connection with 160 mm diameter



Edge Sander FS 900 K, FS 900 KF

- Variable speed sanding table tilting 90°–45°
- Setting range of the table height 150 mm
- belt drive rollers with a 80 mm diameter and 160 mm diameter
- The sanding belt speed is 11 m/sec.
- Oscillating sanding belt by means of independent oscillating motor, sanding belt size 2200 x 150 mm



Hammer® The obvious choice

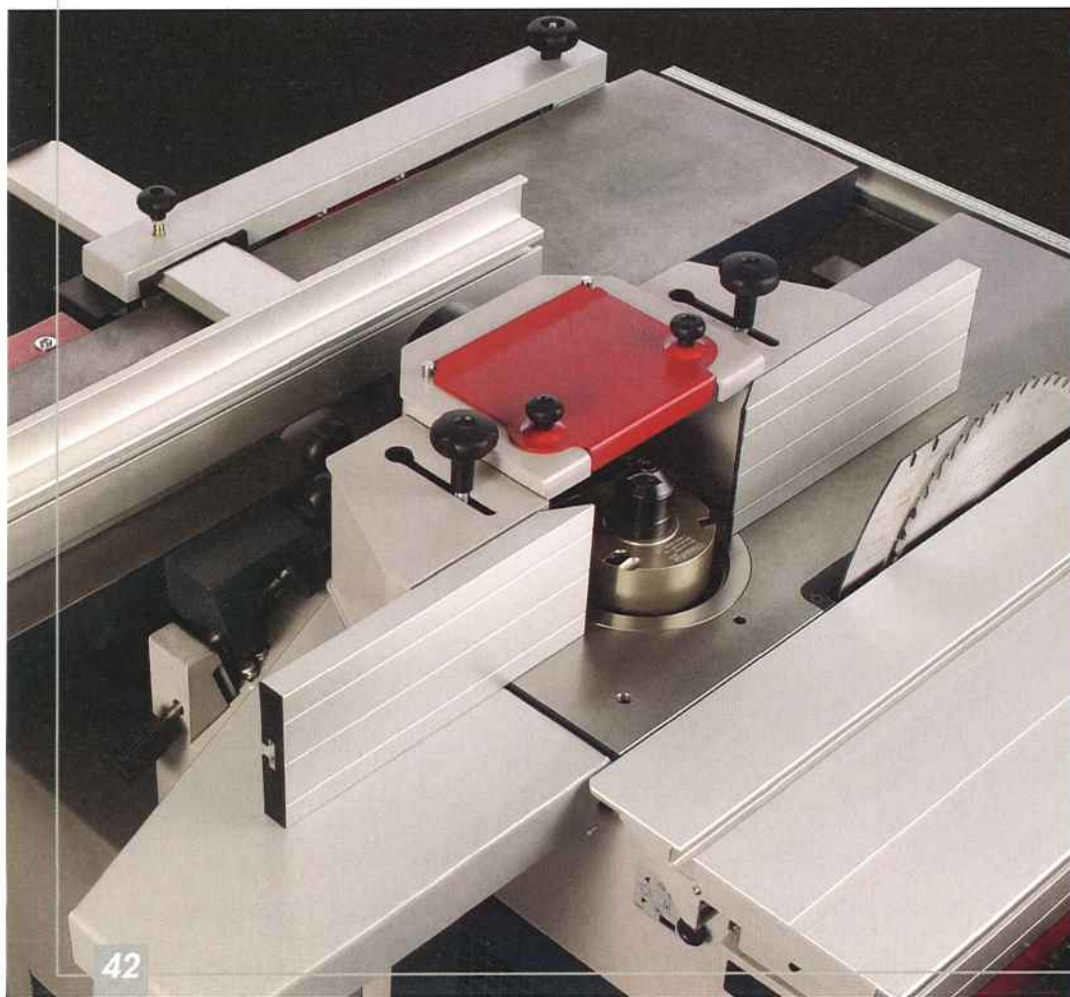

High-grade machines at a low price – perfect for newcomers to the wood-working trades.

Right down to the last detail we orientate ourselves according to the needs of the discerning woodworker. Continuous development and elaborate solutions have made this series a bestseller among hobby and professional cabinet-makers alike!

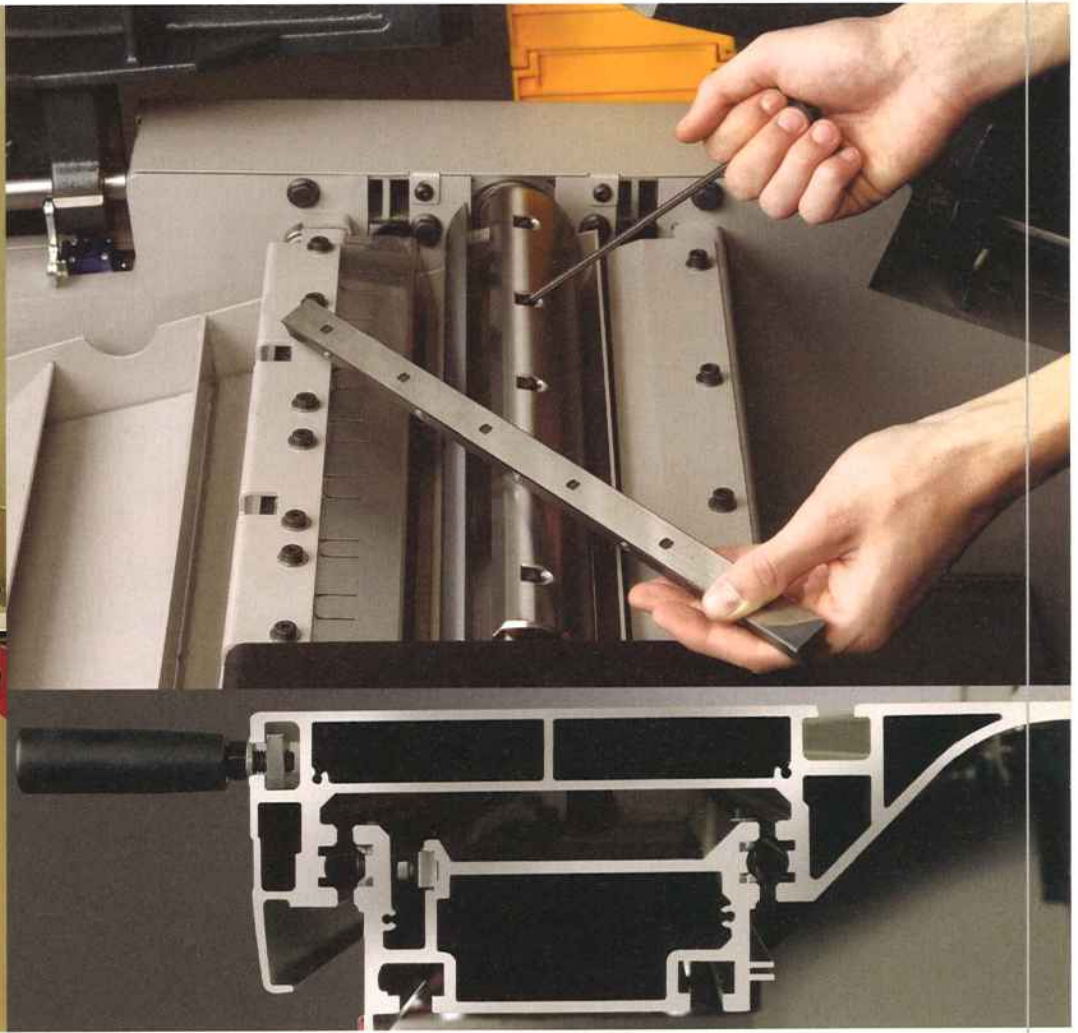

There are many reasons for this: for example, the large-dimensioned aluminium sliding table with a precision guiding system that moves smoothly, the new fences for the table saw, moulding and planing work, or the usual high manufacturing quality that is expected of a machine made in Austria.

Even during your first hours of work you will experience the harmonious interplay of the components in your Hammer.

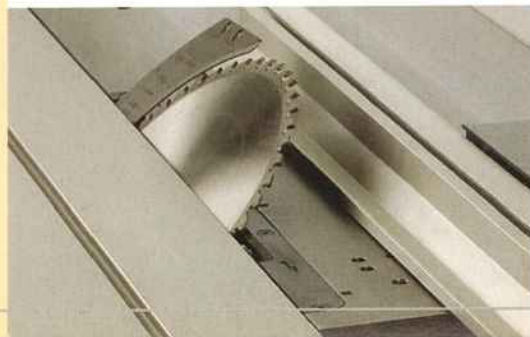
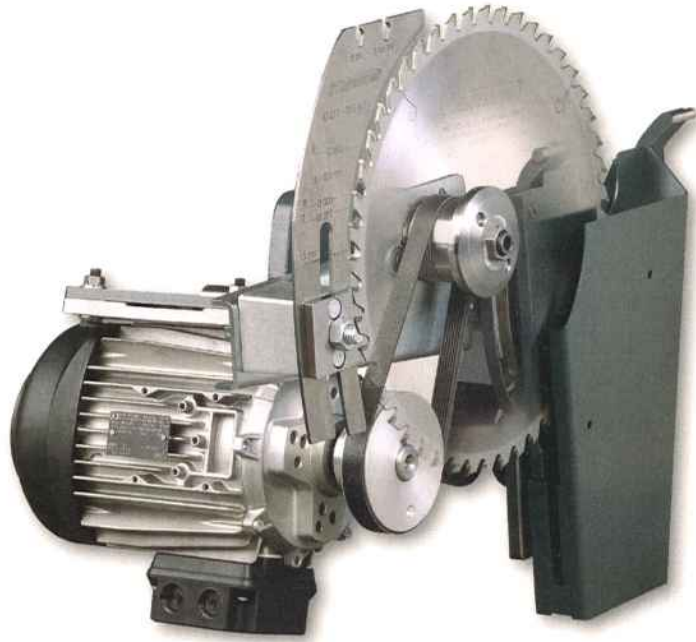

Hammer®

the 3 ranges, basic winner and perform can be tailored to suit your personal requirements

C3 31



A powerful package of performance and precision in a compact unit!

C3 31, a hobby workers dream! Modern machine technology grants quick change over times for either planing, sawing, moulding or mortising.

User friendliness and precision = wood working enjoyment. We know that and that is why we offer you high quality technology for a sensational price performance ratio!

A3 31



Sensational quality + technology, outstanding planing results!

A3 31 continues the range of impressive Hammer machines.

A thickness planer that is impressive not only because of its performance but also because of its build.

The solid planing table made of cast iron, the automatic planer knife system and the best operating quality guarantees perfect planing and thicknessing results of the A3 31!

A3 41

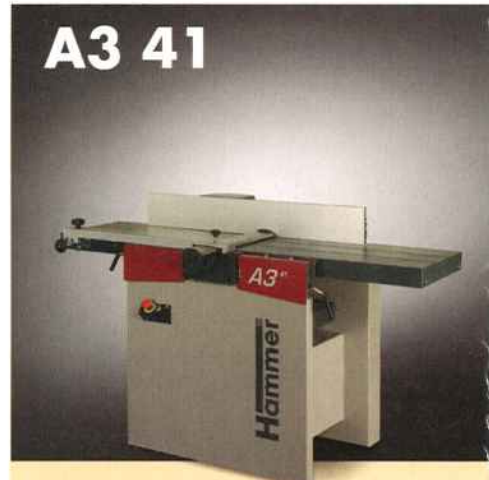

410 mm planing width for the true woodworking professional!

A3 41 - Sensational results for an unbeatable price, you will only find these at Hammer!

Details such as the long, solid milled planer table made of cast iron give precise planing work.

The 3 knife quick-change, self-setting cutterblock enables planer knife change in a matter of seconds and produces a finish that will please even the most critical eye.

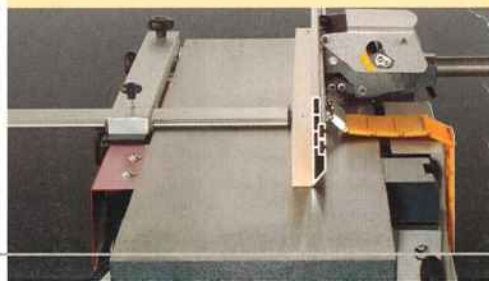
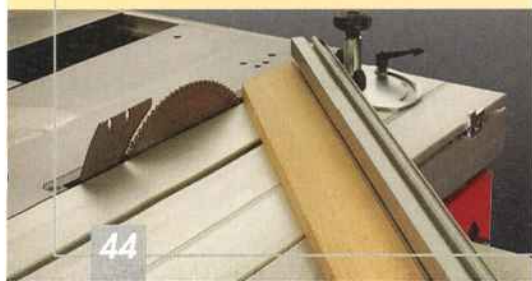

B3 winner

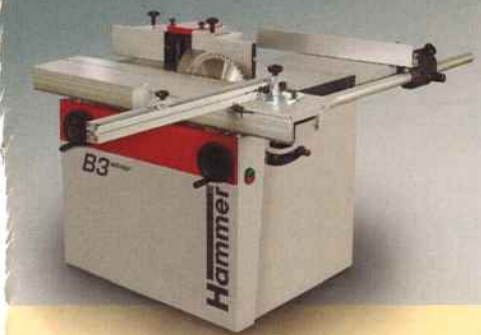

Sawing and moulding for the demands of high quality and performance!

A saw spindle moulder with the best handling qualities and high safety guaranteed uncompromised quality for years!

An easier and smoother sliding action, the generous dimensions of the format sliding table, easy tool change, outstanding machine technology and extreme user friendliness are the advantages that you will notice when you work with the B3 winner.

For the small work shops with high demands, we have something very special: the B3 basic!

Flexible adaptation of the working table dimensions with the Hammer table extension system or unrestricted mortis work.



F3



The F3 spindle moulder, a highly flexible moulder at a great price!

The quick change of speed, the accurate and time saving adjustments, the professional spindle moulder fence, the tilting moulder spindle and the slot and tenon table are the highlights, that fill every wood working professional with enthusiasm!

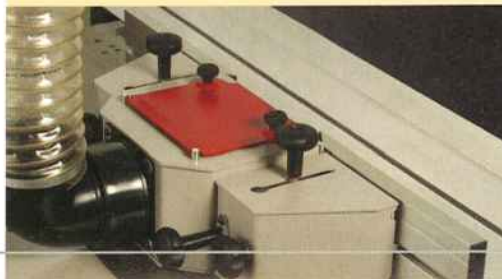

K3 winner



The small precision circular saw for a price that doesn't break the bank!

The K3 basic precision circular saw is required in craftwork shops and industries for various jobs. The high quality guiding system of the Hammer format sliding table, the double mitre system for the length and mitre cutting, and the tilting circular saw unit, = the ingredients for highly precise circular saw jobs!

K3 winner – Built for the woodworker, that appreciates high quality! With precise length, mitre and format cutting - every detail has been thought through and optimised.

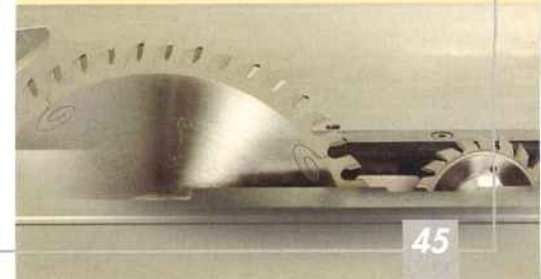

Hammer®

The powerful HAMMER line, perfectly suited for the constant demand of daily use in various trades and industries

C3 31 perform

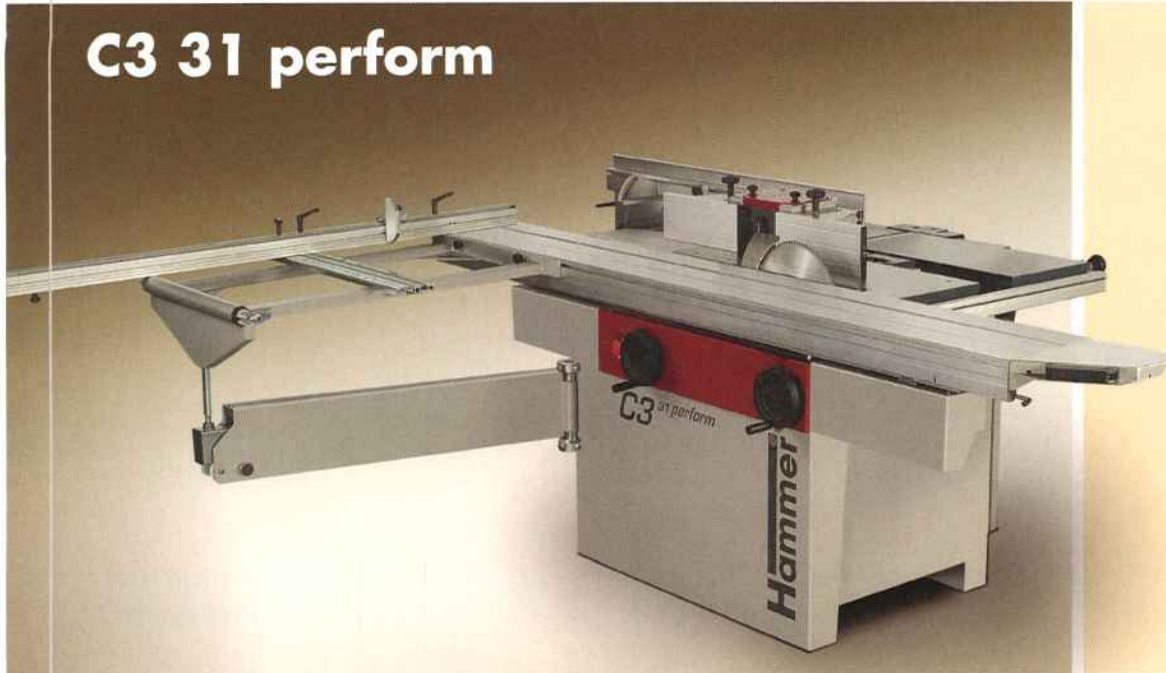

B3 perform

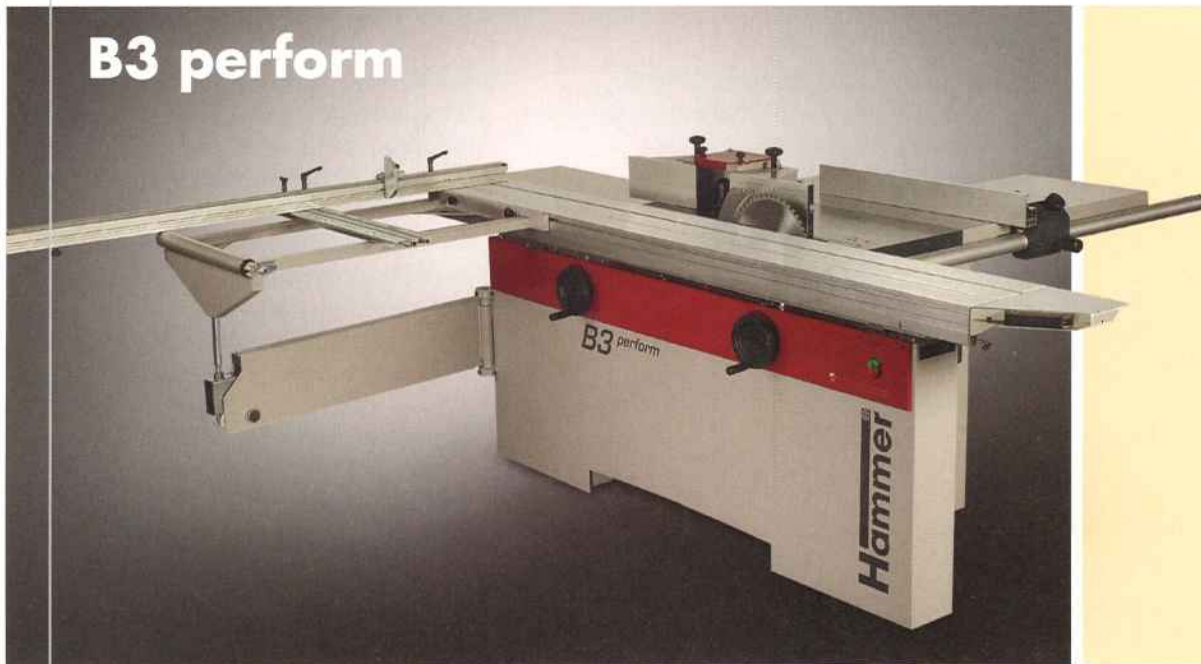

K3 perform

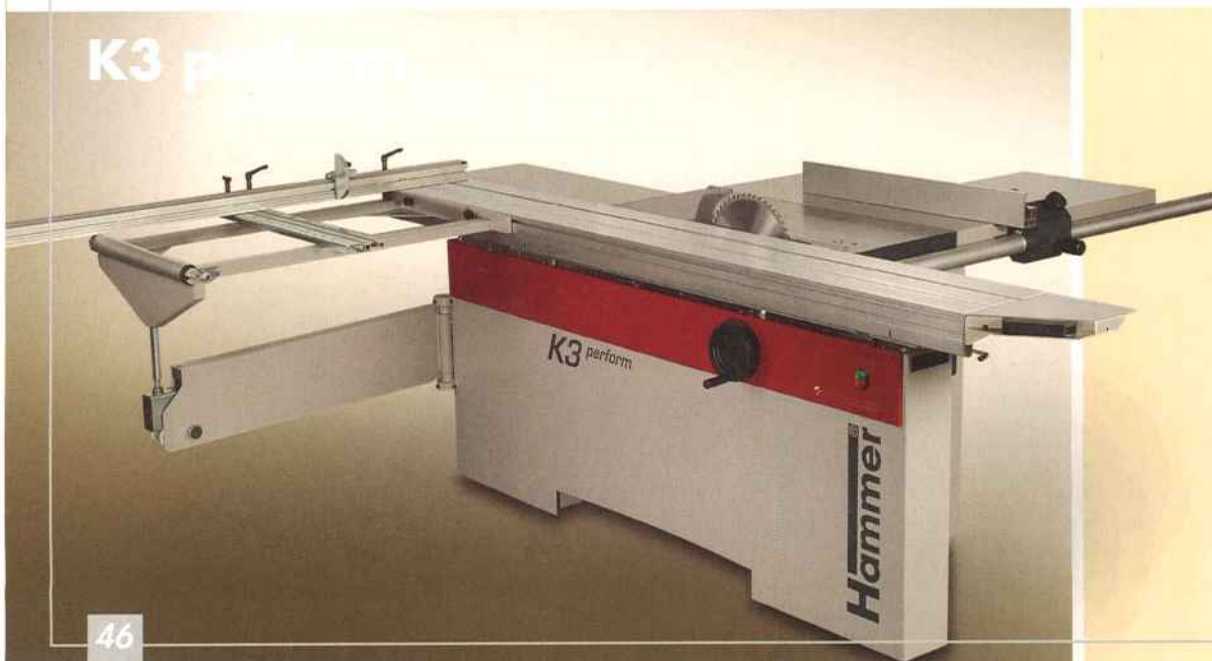

A powerful package of performance and precision in a compact unit

Is it possible to carry out professional surface planing and thickening, moulding, format cutting and as an option, slot mortising even in the smallest of spaces? With the C3 31 perform, these tasks are no problem!

The C3 31 perform offers you the finest machine technology, exceptional performance and a great deal of precision while occupying very little space.

The extraordinary user-friendliness, the various possibilities for making accurate adjustments, the short changeover times and the high-quality workmanship that Hammer puts into each machine ensure that you are investing in a product that will serve you well for many, many years.

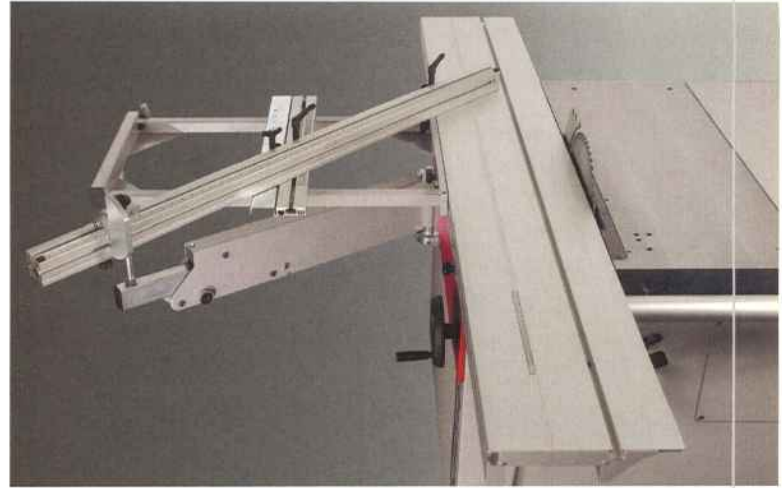

Format circular saw with integrated spindle moulder

Even a combination machine can fulfill professional demands – provided it is made by Hammer!

The B3 perform is thoroughly impressive both as a format circular saw and as a spindle moulder. Details like the sturdy industrial format sliding table, the large outrigger table with work-piece roller, the bevelled scale on the crosscut fence which is inclined towards the operating position, the professional rip fence guided on the large round bar, the four speed spindle moulder with professional moulder fence put the Hammer B3 perform in a class of it's own.

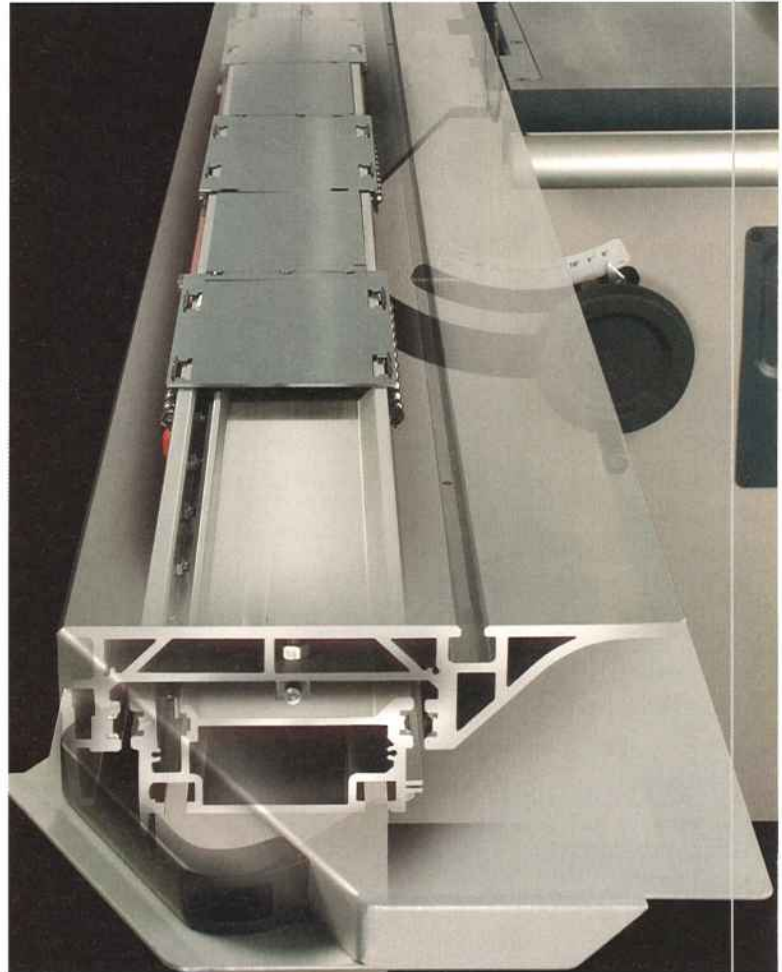

The most powerful HAMMER format circular saw of all time!

If you are of the opinion that format cuts up to 3200 mm need to be accurate but not expensive, then the K3 perform should be your machine of choice. Behind the concept of the Hammer perform machines stands a range of features that guarantee both precision and user-friendliness in your daily work. The sturdy industrial format sliding table, the large outrigger table with work-piece roller, the bevelled scale on the crosscut fence which is inclined towards the operating position or the professional rip fence guided on the large round bar are details which put the Hammer K3 perform in a class of its own.

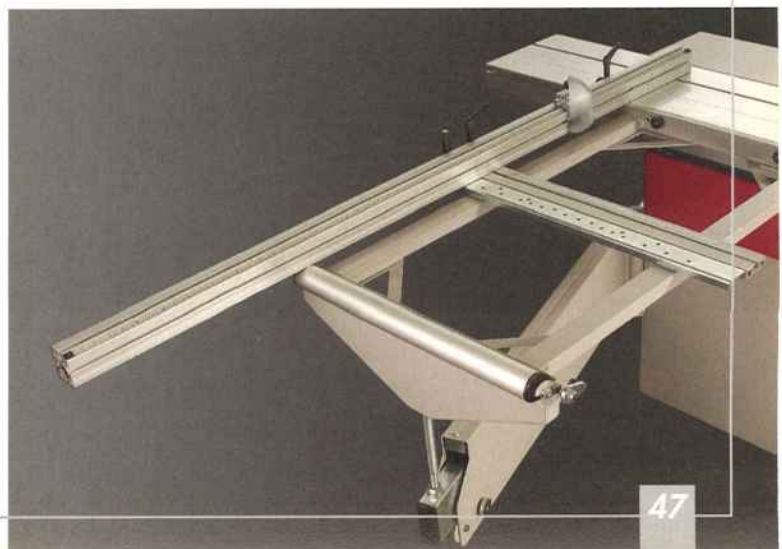

Technical data HAMMER

	C3 31	C3 31 perform	A3 31	A3 41	B3 winner	B3 perform	K3 winner	K3 perform	F3
Electrics									
3x 400 V motor voltage	S	S	S	S	S	S	S	S	S
3x 230 V motor voltage*	-	-	W	W	W	W	W	W	W
1x 230 V motor voltage	O	O	O	O	O	O	O	O	O
50 Hz motor frequency	S	S	S	S	S	S	S	S	S
Motor power 4.0 HP (3.0 kW) S6/40%	S	S	S	S	S	-	S	-	S
Motor power 5.5 HP (4.0 kW) S6/40%	-	-	O	O	O	S	O	S	O
Motor power 7.5 HP (5.5 kW) S6/40%, Star-Delta-Start	-	-	-	-	-	-	-	O	-
Forward and Reverse Run	S	S	-	-	S	S	-	-	O
Surface Planer and Cutterblock									
3 knife quick-change, self-setting cutterblock system	S	S	S	S	-	-	-	-	-
3 knife standard-knife cutterblock	O	O	O	O	-	-	-	-	-
Maximum depth of cut	4 mm	4 mm	4 mm	4 mm	-	-	-	-	-
Surface planing width in mm	310	310	310	410	-	-	-	-	-
Planer table length in mm	1400	1400	1400	1700	-	-	-	-	-
Planer fence tilting from 90°-45°, anodised	S	S	S	S	-	-	-	-	-
Length of surface planer fence in mm	150 x 1150	150 x 1150	150 x 1150	150 x 1100	-	-	-	-	-
Thickener unit									
Thickening planing width in mm	306	306	306	406	-	-	-	-	-
Thickening table length in mm	540	540	540	640	-	-	-	-	-
Minimum/maximum thickening height 4-225 mm	S	S	S	S	-	-	-	-	-
Synchronized feeder drive 6 m/min. (50 HZ)	S	S	S	S	-	-	-	-	-
Saw Unit									
Main saw-blade Ø 250-315 mm, Saw unit speed 4800 rpm	S	S	-	-	S	S	S	S	-
Saw-blade tilting from 90°-45°, Max. cutting height 103 mm	S	S	-	-	S	S	S	S	-
Saw-spindle moulder table in mm	860 x 300	860 x 300	-	-	950 x 385	950 x 385	950 x 385	950 x 385	950 x 370
Rip capacity continuously adjustable	0-600	0-600	-	-	0-800	0-800	0-800	0-800	-
Cutting width 800 mm with full table	-	-	-	-	O	O	O	O	-
Cutting width continuously adjustable 0-1250 mm	-	-	-	-	O	O	O	O	-
Preparation for Dado tooling up to 15.5 mm width	O	O	-	-	O	O	O	O	-
Rip fence with large round guiding bar	-	-	-	-	S	S	S	S	-
Fine Adjustment for Rip Fence	O	O	-	-	O	S	O	S	-
Mechanical scoring unit, scoring blade dia. 80 mm	O	O	-	-	O	O	O	O	-
Scoring unit, Motor 1.0 HP (0.75 kW)	-	-	-	-	-	O	-	O	-
Spindle Moulder Unit and Spindle Fence									
Fixed spindle with height adjustment from the front	S	S	-	-	-	-	-	-	-
Spindle moulder tilt 90°-45°	-	-	-	-	S	S	-	-	S
Speed 3000/6000/8000/10,000 rpm	S	S	-	-	S	S	-	-	S
Moulder spindle dia. 30 mm, usable height 100 mm	S	S	-	-	S	S	-	-	S
Router spindle 14,000 rpm instead of dia. 30 mm	O	O	-	-	O	O	-	-	O
Spindle moulder fence 220 for max. tooling diameter 220 mm	S	S	-	-	S	S	-	-	S
Table opening 90°	180	180	-	-	180	180	-	-	180

	C3 31	C3 31 perform	A3 31	A3 41	B3 winner	B3 perform	K3 winner	K3 perform	F3
Anodised "X-Roll" Sliding Table									
Format sliding table 800 mm, Cutting length 865 mm**	S	-	-	-	-	-	-	-	S
Format sliding table 1250 mm, Cutting length 1300 mm**	O	-	-	-	S	-	S	-	O
Format sliding table 2000 mm, Cutting length 2050 mm**	O	-	-	-	O	-	O	-	O
Format sliding table 2500 mm, Cutting length 2500 mm**	-	S	-	-	-	S	-	S	-
Format sliding table 3200 mm, Cutting length 3200 mm**	-	-	-	-	-	O	-	O	-
Outrigger Tables and Crosscut Fences									
Outrigger table 1100	O	-	-	-	O	-	O	-	O
Outrigger table 1250	-	S	-	-	-	S	-	S	-
Precision mitre guide index system	O	O	-	-	O	O	O	O	O
Crosscut fence 900 mm for all sliding table	S	O	-	-	S	O	S	O	O
Telescopic extension 750 mm for crosscut fence	O	-	-	-	O	-	O	-	O
Crosscut fence 1300 mm for outrigger 1100***	O	-	-	-	O	-	O	-	O
Crosscut fence 1300 mm for outrigger table instead of crosscut fence 900 mm***	O	-	-	-	O	-	O	-	-
Crosscut fence 2600 mm for outrigger 1250	-	S	-	-	-	S	-	S	-
Mortising Unit									
Mortising table	O	O	O	O	-	-	-	-	-
Mortising chuck 0-16 mm	O	O	O	O	-	-	-	-	-
Weight									
Weight in kg (net/gross)****	540 / 610	700 / 780	300 / 350	450 / 520	330 / 400	500 / 570	280 / 350	450 / 520	280 / 350

S Standard equipment, W Optional equipment at no extra cost, O Additional extras, PA Price on request

* Min. output 5.5 HP (4,0kW), ** Max. cutting length with outrigger and pre-groover at a cutting height of 300 mm, *** Only in combination with Outrigger 1100,

**** Average weight with an average number of additional fittings

Bandsaws – from small to large



N4400



Looking for a bandsaw that is flexible, well equipped for a reasonable price?
Then you are exactly right with the N4400!

... impressive features that you will only find on the Hammer N4400 bandsaw:

Standard features include saw-blade guides both above and below the table, saw blade tension indicator, tilting machine table and many others – a comprehensive package at a reasonable price!

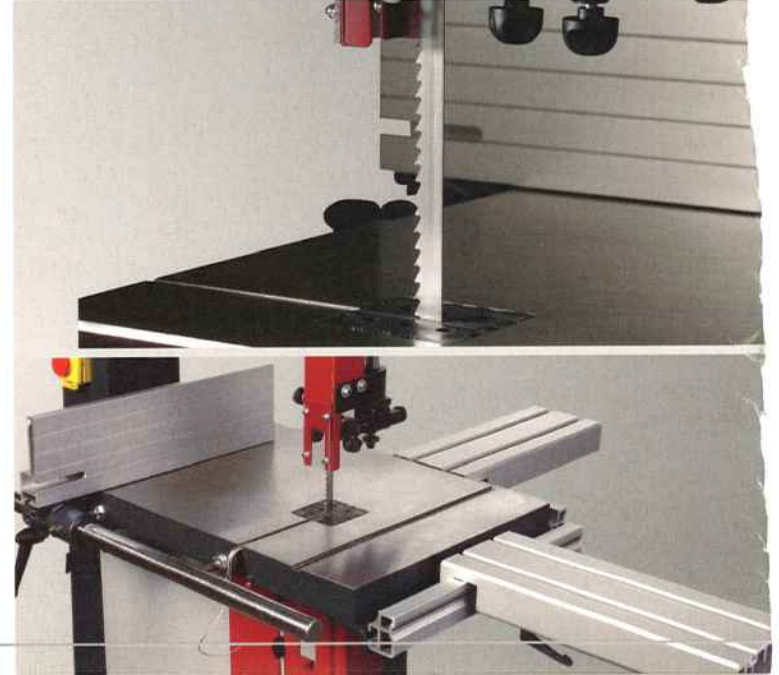
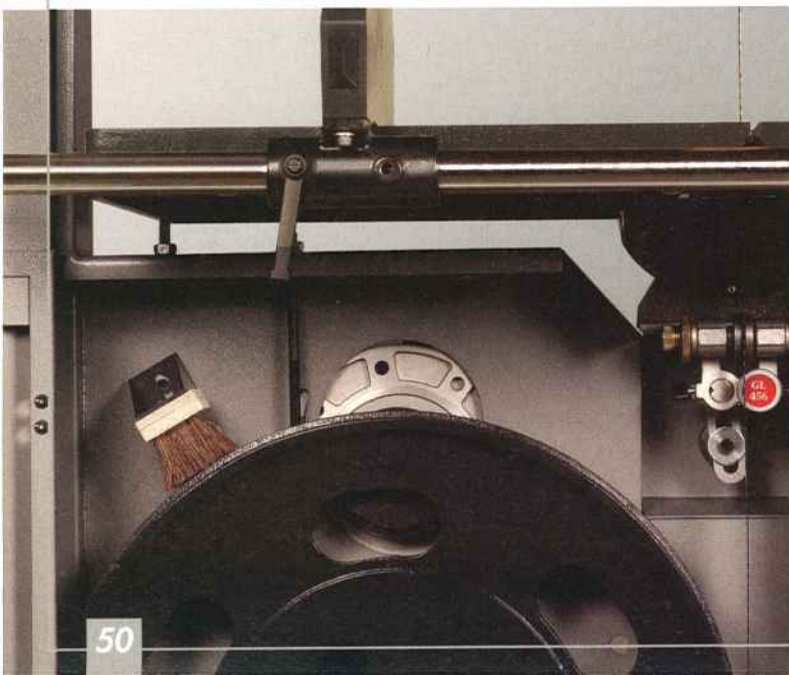
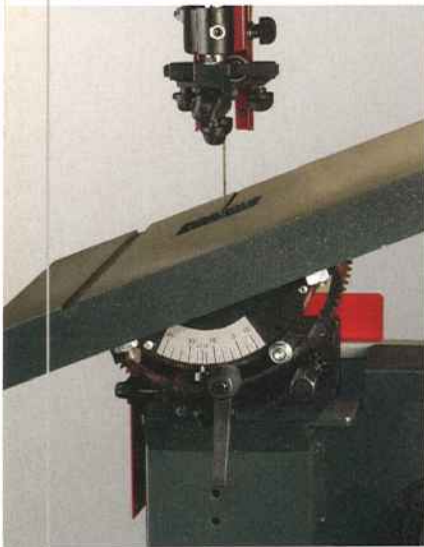

FB 400
FB 500
FB 600



FB 540
FB 640
FB 740
FB 840



Quality in every detail
FELDER bandsaw FB 400/500/600

A successful mixture of mature technical innovations and functions, for a fantastic price.

High quality details such as the cast iron table (tilting 0°–20°) and the stable fences, were developed by experienced specialists.

Accessories, such as the combination of circle cutting, sanding device and the mitre fence/mitre stop with a variable setting of saw blade angle (-45° up to +45°) completes the perfection in sawing on your Felder bandsaw.

Perfection in every detail is really important to us! FB 540/640/740/840 - its impossible to find anything more perfect!

These bandsaws belong to our best selling machines, and offer the technical detail solutions that will convince any professional carpenter.

Standards, such as the cutting capacity of 520–810 mm, a cutting height of 350–520 mm and a roller diameter of 540–840 mm make these machines the best amongst bandsaw machines!

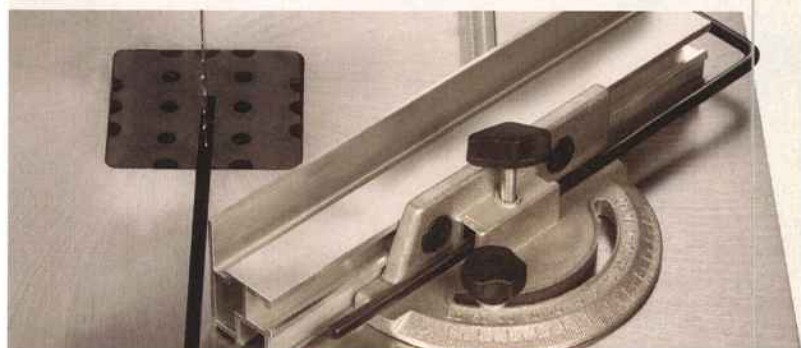

A small extract from our tools and accessories programme!
For more check out www.felder-group.co.uk

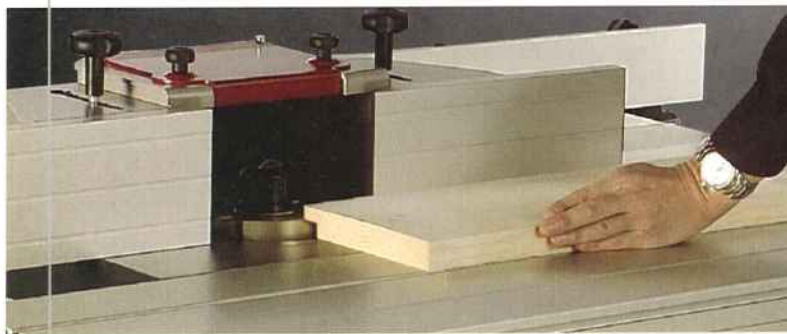

Dust Extractor Accessories and Dust Extractors



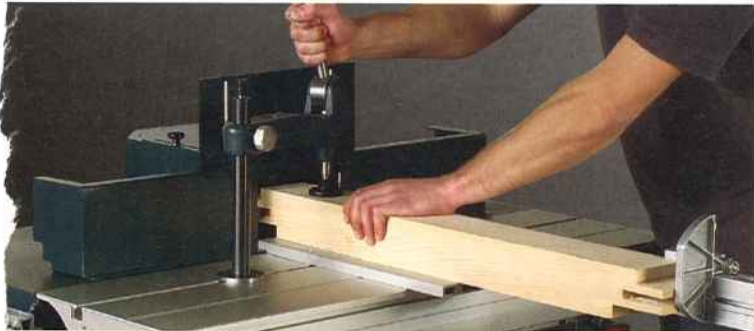

5 good reasons ... why you should choose a product from the FELDER GROUP:



Woodworking machines from the FELDER GROUP are machines that you can rely on

Well engineered solutions, innovative further development and an uncompromising quality, are the signs of the woodworking machines of the Felder group. Decisive criteria such as stability, functions and long life are for our machines a must.



Advice that you can rely on!

From the first moment on you will get from us professional consultation and care. Our consultation team will be available to advise you at any time on your new wood working machine investment.



Reliable machines made in Austria!

Felder Group woodworking machines are top quality Austrian products. 100% of the production and development is carried out at the factory in Hall in Tirol. With the most up-to-date mechanical engineering and production techniques, combined with continuous quality control procedures, guarantee the quality, precision and the reliability of your new woodworking machine.



Our servicemen are always ready!

Our customer care and service staff are continuously trained by specialists. The Felder Group factory subsidiaries and representatives that are near you, ensure you receive top quality after sales service and support.



Machines built to order!

Every Felder Group machine is produced specifically to the customers wishes. The answer to your dreams!

Satisfied customers worldwide, for over 50 years!

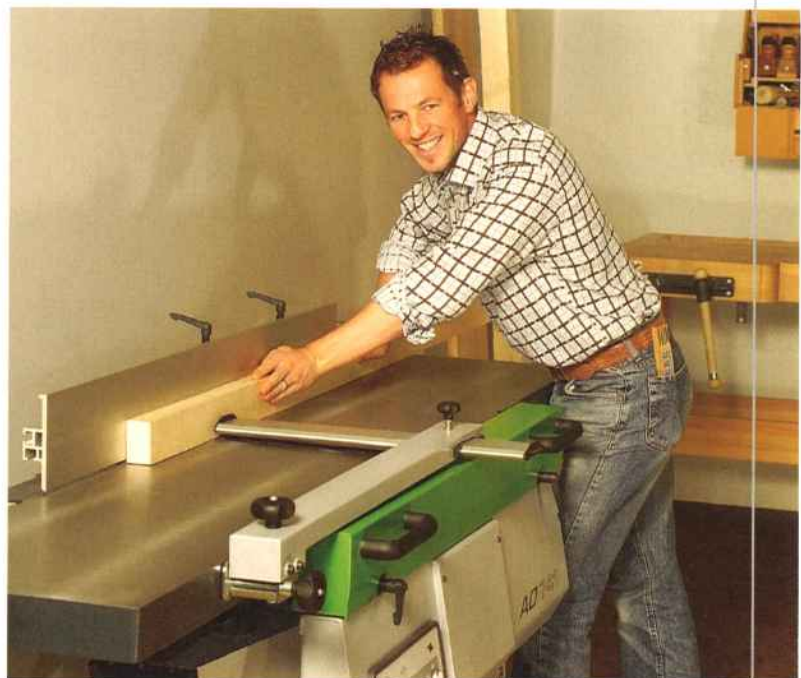

„Woodworking is my favorite hobby and it helps to forget everyday stress! With the FELDER CF 731 every work piece, is a small work of art.“

Manfred Thaler (Felder customer since 2000)

„When i set up my own workshop 15 years ago, i equipped it with FELDER machines, today i am still very satisfied with them. Because they still achieve what they promised!“

Peter Zimmermann (Felder customer since 1991)

„I could not imagine to install a complete work shop in such a small area, but HAMMER made it possible!

As a trained carpenter i am used to working with solo machines!“

Christian Stefensen (Hammer customer since 1989)



„5 years ago i invested in a FORMAT-4 woodworking system and i was pleasantly suprised, the machine is very flexible and is easy to operate, from the very first moment it has functioned perfectly!“

Jochen Neuhauser (Format-4 customer since 2001)



Investment goods and leasing – A smart decision!

The following points present a strong argument for a decision to lease:

- Leasing secures and improves liquidity
- Leasing allows for additional returns – available funds can be used for other purposes
- Leasing alleviates current rationalisation measures
- Leasing finances itself out of the returns made on the leased machine
- Leasing stabilises the balance sheet structure
- Leasing creates a clear basis for calculations
- Leasing saves taxes

In financially tough times it is hard to find ways and means to invest in new machinery. Cash is at a premium and banks are very cautious with their lending criteria. Leasing provides a solution to this financial problem particularly when new machinery is necessary for the competitiveness of your business.

Better: Leasing (=business rental facility) instead of buying

Leasing can best be described as “business rental facility” the customer has the use of the asset without the need for capital outlay, rather through payment of regular rentals. Virtually any type of asset can be financed with a “Lease Purchase” agreement where there is also an option to purchase the asset at the end of the agreed term.

From small business to large industry: Lease and reduce your tax bill

Depending on the country it is possible to off-set your lease payments against your gross profit, a huge advantage for any business. Just as many other operating expenses such as workshop rent or electricity are deducted from the gross profit so can your monthly machine leasing payments. This reduces your net profit and therefore your tax bill!

Leasing saves your capital

The possible credit play at the bank of the leaseholder stays open for other important issues (e.g. marketing etc.)

Leasing better than borrowing!

The criteria for leasing are generally less stringent than that of obtaining a bank loan. Since you are investing in machinery which will provide a significant return over a long period of time, institutions are more inclined to favor leasing.

Why not give us a call right now?
We'd be happy to consult you!



Visit us on the internet ...

www.felder-group.co.uk

... and take advantage of the following:

- The complete Felder Group range of machines to choose from and to compare.
- To access machine prices!
- The best used machines, with all the machine details for unbeatable prices!
- Online shopping - for ordering in comfort at home: Tools, fittings and extractor programmes with lots of special offers!
- Online - to order our FREE catalogue.

**we look forward
to your visit!**

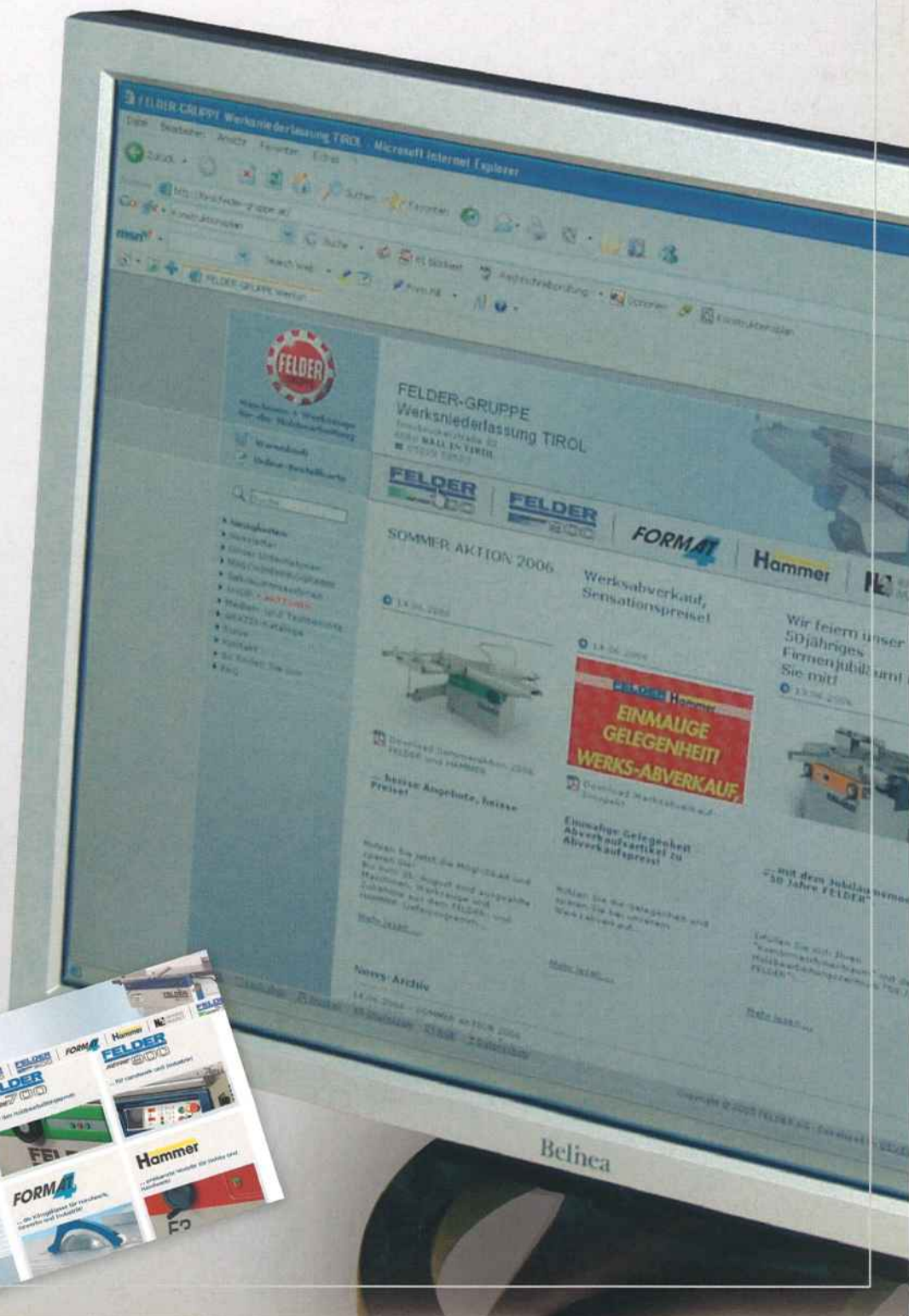



FELDER

FORMAT

Hammer

FELDER UK

- Milton Keynes 01908 635 000
- Leeds 08450 712224

FELDER Scotland

- Glasgow 08450 712225

e-mail: sales@ukfelder.co.uk

www.ukfelder.co.uk

ALGERIA · AUSTRALIA · AUSTRIA · BAHRAIN · BELGIUM · BOSNIA · BULGARIA · CANADA · CHINA · COLOMBIA · CROATIA · CZECH REPUBLIC · DENMARK · ECUADOR · ESTONIA · FINLAND · FRANCE · GERMANY · GREECE · HUNGARY · ICELAND · INDIA · IRAN · IRELAND · ISRAEL · ITALY · JAPAN · KAZAKHSTAN · KOREA · LATVIA · LITHUANIA · MAURITANIA · NETHERLANDS · NEW ZEALAND · NICARAGUA · NORWAY · POLAND · PORTUGAL · QATAR · ROMANIA · RUSSIAN FEDERATION · SINGAPORE · SERBIA & MONTENEGRO · SLOVAKIA · SLOVENIA · SOUTH AFRICA · SPAIN · SWEDEN · SWITZERLAND · TAIWAN · TÜRKİE · UKRAINE · UNITED ARAB EMIRATES · UNITED KINGDOM · UNITED STATES · YUGOSLAVIA

© 12/2006 FELDER® · A-6060 Hall in Tirol · Austria · Heiligkreuzerfeld 18 · Tel. ++43 (0) 5223 58500 · Fax ++43 (0) 5223 56130 · E-Mail: info@felder.at
Prices, technical data and printing errors are subject to changes without notice.