

PANHANG

**Holzbearbeitungs-
maschinen**
seit 1918

PANHANS

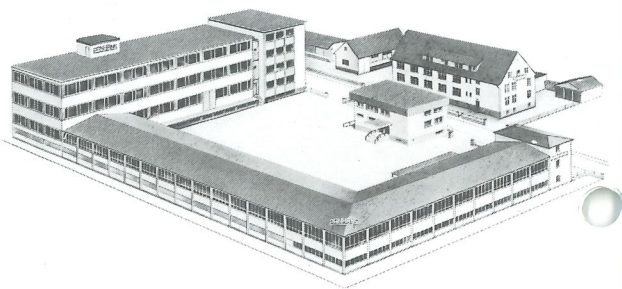

Werk Sigmaringen (Baden-Württemberg)
Plants Sigmaringen (Federal Republic of Germany)
Usine de Sigmaringen (Allemagne d'Ouest)

PANHANS

Typ 261

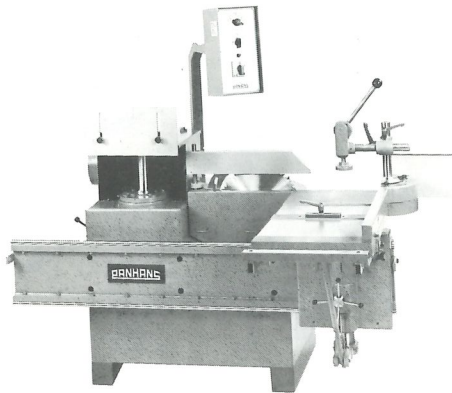

Zapfenschneider
Tenoning and Slotting Machine
Tenonneuse

PANHANS

Typ 250

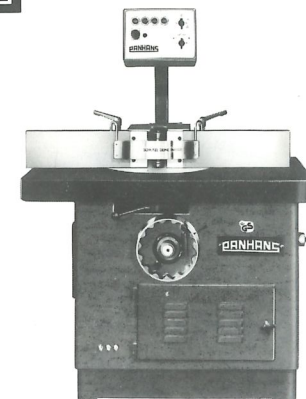

Schwere Starrfräsmaschine
Shaper-Fixed Spindle
Toupie lourde

Ein hervorragendes MASCHINENPROGRAMM

PANHANS

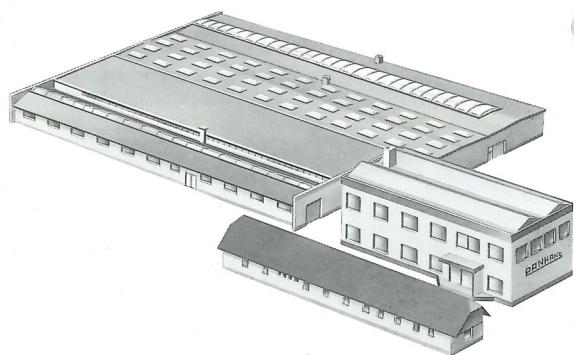

Werk Micheldorf (Ober-Österreich)
Plants Micheldorf (Austria)
Usine de Micheldorf (Autriche)

PANHANS

Typ 240

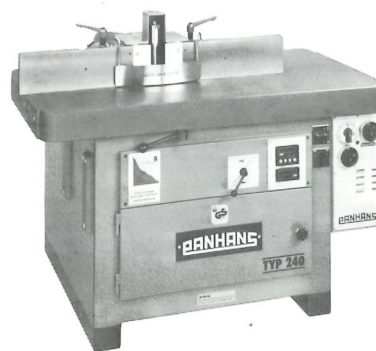

Produktions-Schwenfräsmaschine
Heavy-Duty Shaper - Tilttable Spindle
Toupie à arbre inclinable de haut rendement

PANHANS

Typ 259

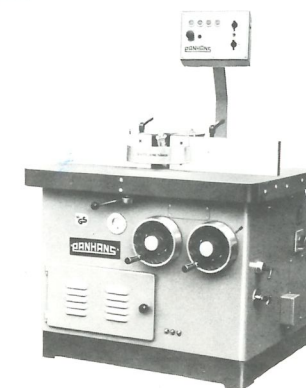

Schwere Schwenfräsmaschine
Shaper-Tilttable Spindle
Toupie lourde à arbre inclinable

PANHANS

Typ BSB

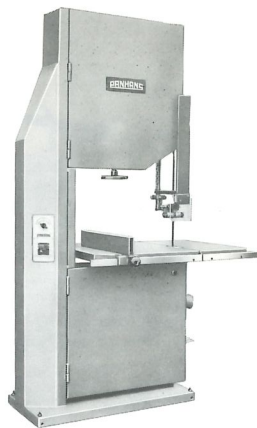

Bandsägemaschine
Bandsaw
Scie à ruban

PANHANS

Typ 425/426

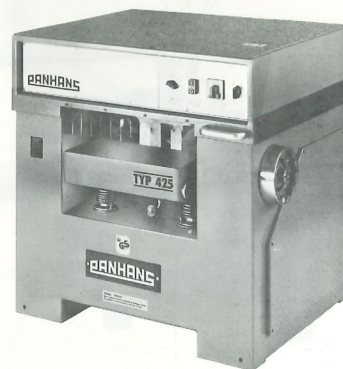

Dickenhobelmaschine
Thickness Planing Machine
Raboteuse

PANHANS

Typ 445/A-446/A

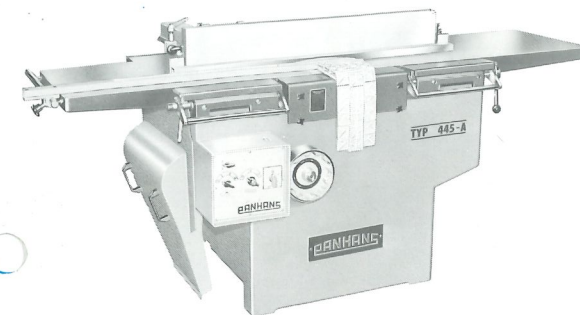

Komb. Abricht- u. Dickenhobelmaschine
Combined Surface and Thickness Planing Machine
Machine combinée à dégauchir et à raboter

M für den anspruchsvollen Holzfachmann

PANHANS

Typ 116



Langlochbohrmaschine
Horizontal Slot Mortising Machine
Mortaiseuse à mèche horizontale

PANHANS

Typ 435



Dickenhobelmaschine
Thickness Planing Machine
Raboteuse

PANHANS

Typ 324/325

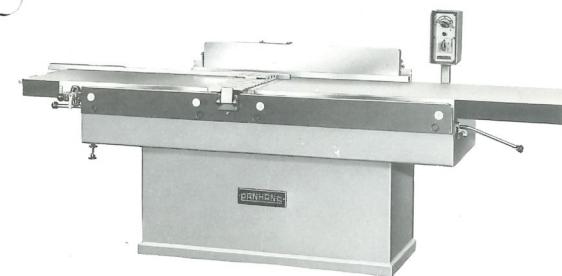

Abrichtobelmaschine
Surface Planing Machine
Degauchisseuse

PANHANS

Typ 1773 F

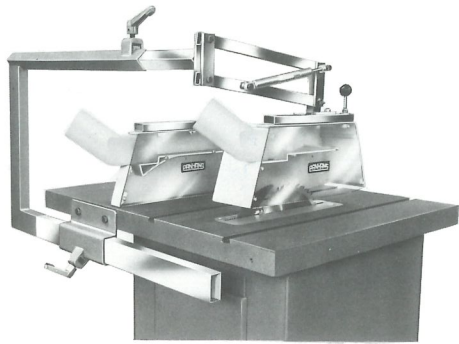

Kreissägen-Schutzvorrichtung
Circular saw protective device
Dispositif de protection pour scies circulaires

PANHANS

Typ 690

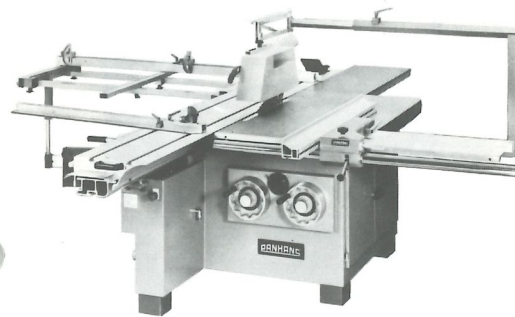

Schrägstellbare Formatkreissäge
Tilttable Sliding Table Panel Saw
Scie à Format à lame inclinable

PANHANS

Typ 690

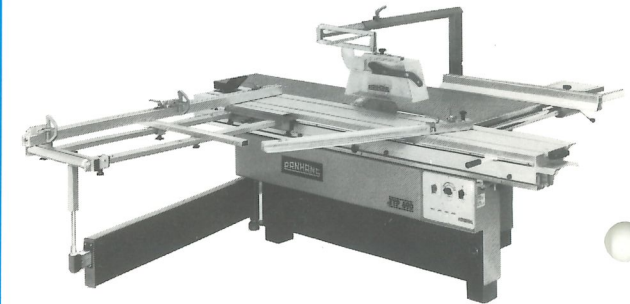

Schrägstellbare Formatkreissäge
Tilttable Sliding Table Panel Saw
Scie à Format à lame inclinable

PANHANS-Maschinen – weltweit ein Begriff für Qualität und Fortschritt

PANHANS

Typ 76

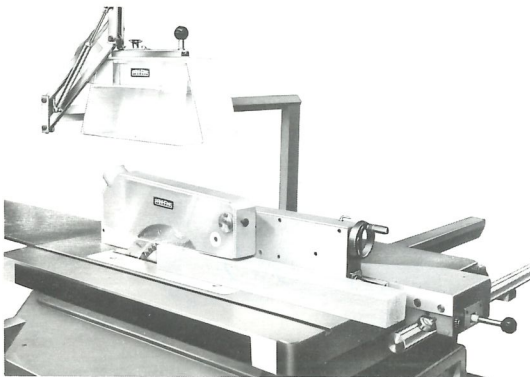

Vorschubapparat
Feeding apparatus
Appareil d'avance

PANHANS

Typ 609

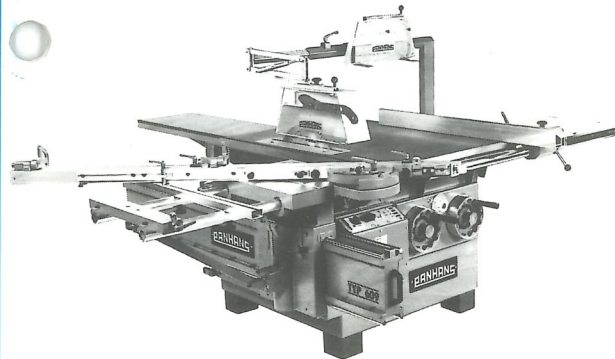

Solo-Schwenkkreissäge
Tilttable Circular Saw
Scie circulaire inclinable

PANHANS

Typ 710

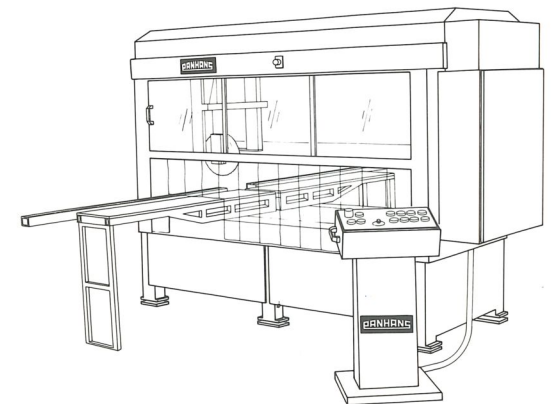

Postforming – Ablängmaschine
Postforming Cross Cut Saw
Postforming Scie à tronçonner

PANHANG

Typ 693/Euro 10
Typ 693/Euro 30

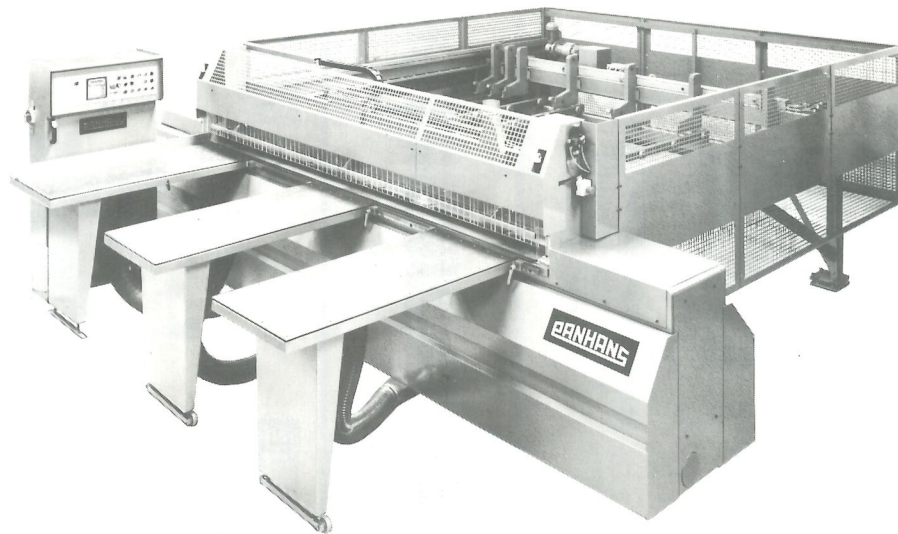

Plattenaufteilsäge

Panel Beam Saw

Scie à diviser les panneaux

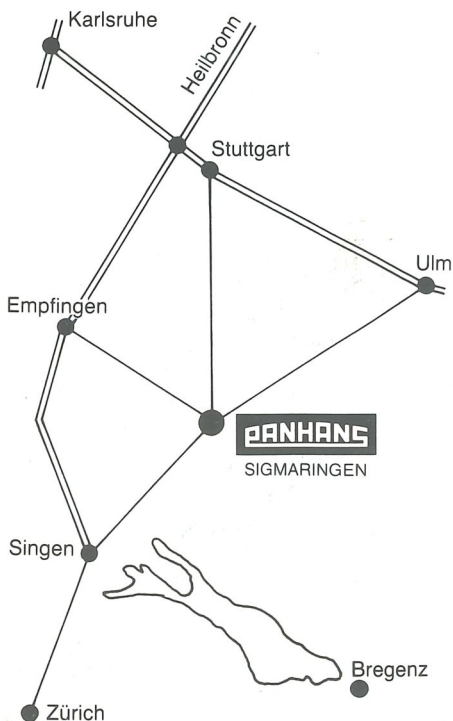

PANHANG

ANT. PANHANS GMBH

Werkzeug- und Maschinenfabrik

D-7480 SIGMARINGEN

Postfach 140 · Telefon (07571) 1621 · Telex 732519

Telefax (07571) 12277